

Partdrawing for CL001GA222 - Steelstofzuiger



6/7/2021

MAKITA SERVICE INFORMATION

Model No.CL001G CORDLESS CLEANER

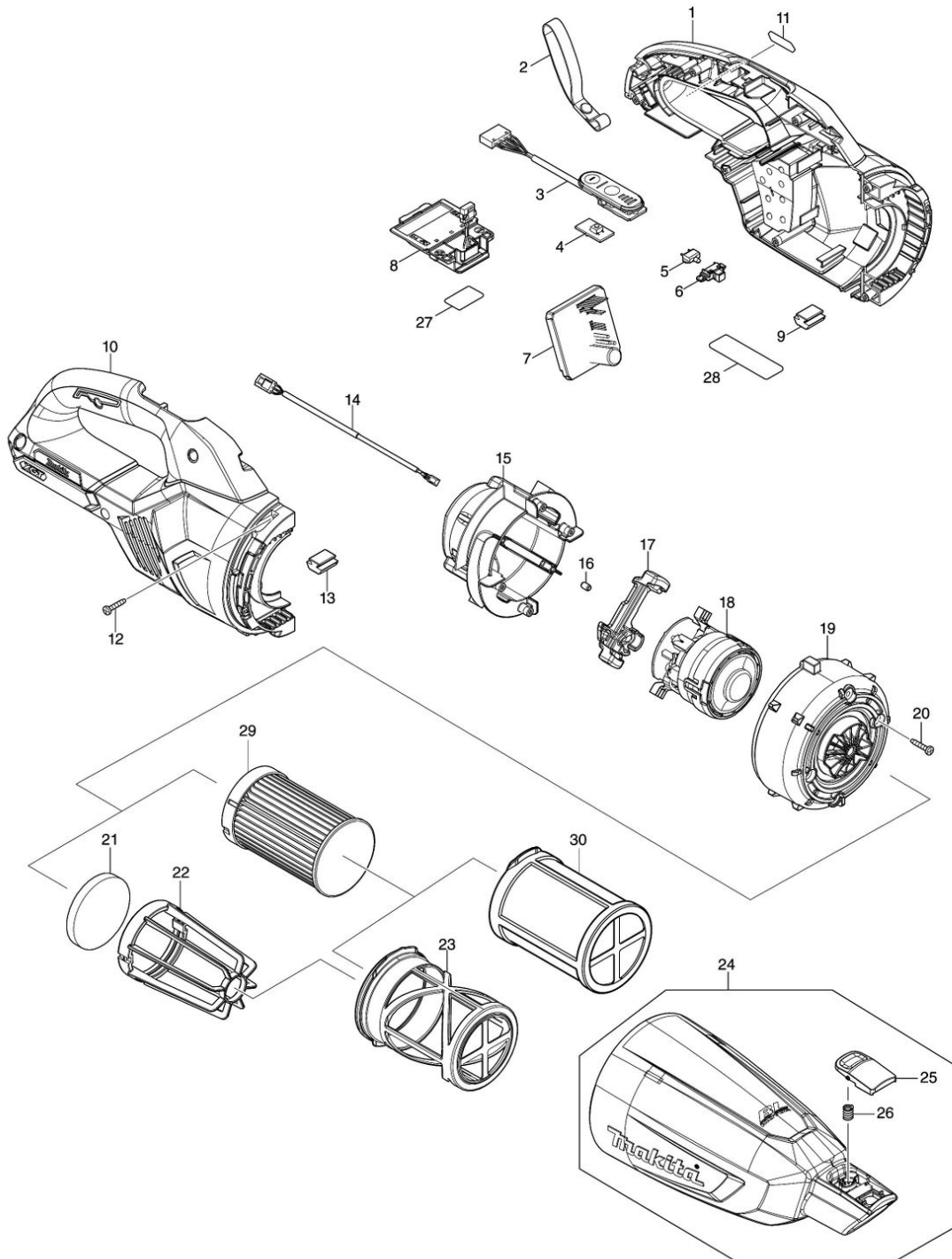

Nr.	Part nr.	Name
001A	183T18-7	Motorhuisset trp-blw CL001G
001B	183T42-0	Motorhuisset BLW CL001G
001C	183T43-8	Motorhuisset BLK CL001G
001C10	263005-3	Rubber Pen 6
001C20	422714-5	Buffer CL001G
003	141B54-1	Circuit indicatie CL001G
003C10	8031J2-9	Label A/U CL001G
004	620E74-1	Schakelaar CL001G
005	620E82-2	Licht circuit DCL281F A
006	459478-8	Kijkvenster DCL281F
007	620E90-3	Toerenregeling CL001G
007C10	688163-8	Lijn Filter Bfs441
008	632P65-6	Controleunit GA-40V serie
009	422460-0	Rubberen plaat DCL281
010A	183T18-7	Motorhuisset trp-blw CL001G
010B	183T42-0	Motorhuisset BLW CL001G
010C	183T43-8	Motorhuisset BLK CL001G
010C10	263005-3	Rubber Pen 6
010C20	422714-5	Buffer CL001G
011	8005T5-8	Label XGT logo
012	266429-2	Tapschroef 3X16 P
013	422460-0	Rubberen plaat DCL281
014	632S32-9	Draadboom CL001G
015	141E55-7	Motordeksel R CL001G
016	263002-9	Rubber Pen 4 6413 A
017	422723-4	Motordekselrubber CL001G
018	629A46-9	Motor CL001G
019	413645-9	Motordeksel F CL001G
020	266429-2	Tapschroef 3X16 P
021	422268-2	Sponsrubber
022	458467-0	Filterhouder DCL/CL-series A
023	199966-0	Linnen stoffilter steelstofzuiger
024	136449-9	Voorhuis trp-blw CL001G
024C10	266326-2	Tap Schroef 4X18Mm
024C20	941051-3	Sluitring M4
024C30	424208-6	Klepventiel CI140
025	458939-5	Schakelknop A DCL281F
026	232485-4	Drukveer 5
027	811M37-8	Label serienr CL001G
028	811M30-2	Naamplaat CL001G