

A new level of comfort

Hawa Junior 100

With unique
performance
guarantee

15
years

Performance guarantee
private use

7
years

Performance guarantee
commercial use

Hawa Junior 100

Sliding comfortably and reliably

New

With the Hawa Junior 100, sliding has reached a new level of convenience. Because the youngest member of the Hawa Junior family, proven itself a million times over, moves wooden doors weighing up to 100 kg with incomparable ease.

An innovative magnetic soft closing system ensures that the required opening forces are a maximum of 22 N. This means that heavy wooden doors can be operated with ease thanks to the Hawa Junior 100 with integrated soft closing mechanism. With the best-in-class running properties, the doors slide on quietly until the Hawa SoftStop stops them very softly. In doing so, you can count on the reliability of a technology that is globally successful and geared to the highest loads. And the beauty of it: You don't see it. All components disappear invisibly in the running track. This is one of the reasons why this sliding fitting harmonizes so perfectly with the current trend towards natural materials and high-quality, puristic interior design.



Moving sliding doors with a maximum of 22 N is child's play – requires less force than a tricycle.



Comfort due to new soft and self closing system for lowest opening force

The Hawa Junior 100 also owes its incomparable comfort to the SoftMove 100 magnetic soft closing system. Opening forces with a maximum of 22 N set new standards in this area.

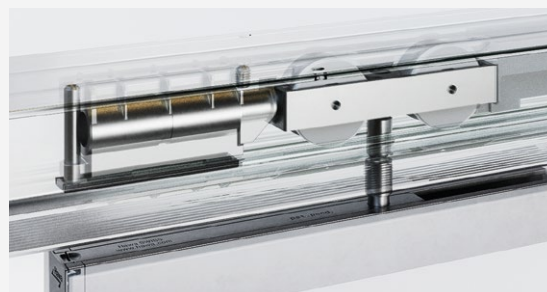

Top running gear for smooth, silent sliding

For decades, Hawa Junior fittings have been synonymous with first-class running properties. And the Hawa Junior 100 seamlessly continues this tradition. Its Comfort rollers and high-precision ball bearings, in conjunction with the other high-quality components, ensure an almost perfect sliding experience. For years and years to come: The system has been tested to 100,000 cycles.

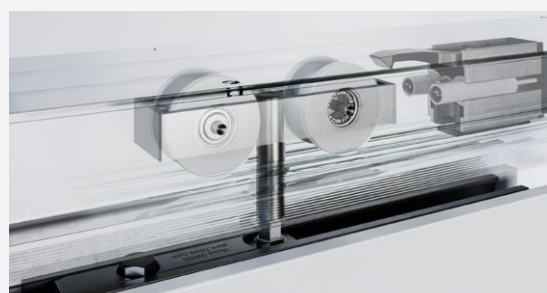

Efficient and safe assembly

The high degree of pre-assembly, which makes both measuring and processing unnecessary, guarantees installers the highest level of efficiency.

Sliding quality is quality of life

Nicer living, better living



With age, the demands for comfort and quality often increase.

Compact construction and new forms of living and the shortage of urban living space require flexible and space-saving room solutions. That is an argument in general for sliding doors. At the same time, the population is ageing, more demanding, and increasingly willing to invest in comfort for the later stage of life.

All of these are the best arguments for a high-quality, durable sliding solution with a soft closing system, which is currently only offered by the Hawa Junior 100. It opens new doors, especially in customer segments with reduced physical strength and capabilities. And with its puristic look and the option for discreet ceiling integration or wall mounting with high-quality side finishes, it also meets the most diverse demands in terms of design.



Unique performance guarantee

Joy that lasts. For a long time.

The Hawa Junior 100 makes the decision for anyone involved in the construction process as easy as opening and moving the doors. Because it is the only sliding fitting that can give you the certainty that the performance will not decrease over the years or years. This means that it meets all requirements, standards, and demands for profitability in the long term – guaranteed.

Especially since Hawa Sliding Solutions not only ensures the longevity of this fitting, but also continued effortless opening. And thus also guarantees that the joy of this fitting will last, even if the strength of its users diminishes due to age or other reasons.

Safety through quality

 <p>15 years</p>	<p>Performance guarantee private use</p>	 <p>7 years</p>	<p>Performance guarantee commercial use</p>
<p>We guarantee effortless opening (maximum 22 N) for private use of the Hawa Junior 100 with SoftMove for 15 years.</p>		<p>We guarantee effortless opening (maximum 22 N) for commercial use of the Hawa Junior 100 with SoftMove for 7 years.</p>	

The performance guarantee is valid worldwide with the exception of contractual partners with their registered office/residence in the USA and use of the products by end users with registered office/residence in the USA.

Benefits at a glance

Comfort, reliability, and aesthetics at the highest level

The new Hawa Junior 100 in brief



Flexibility

New weight class: now for wooden doors up to 100 kg.

Soft closing mechanism on both sides, even for narrow doors from 800 mm.

Solutions for ceiling integration, wall mounting and pocket structures.



Comfort

New magnetic soft closing system with the lowest full accessibility opening force of max. 22 N.

Incomparably quiet running thanks to rollers made of high-performance plastic and precision ball bearings.

Doors are silently braked and pulled closed.



Security

Tested to 100,000 cycles and maintenance-free for the entire service life.

Unique performance guarantee: 15 years for private use and 7 years for commercial use on incomparably low opening forces of max. 22 N

Fulfills the full accessibility standards in accordance with DIN 18040-2 / 25 N.

Accessibility meets the standards of the ADA building regulation in the US.



Productivity

Quick installation and removal, as well as continuous adjustment of the doors.

High degree of pre-assembly and simple storage.



Aesthetics

Simple, reduced design with technology that is invisibly integrated in the running track.

Options for delicate covers and designer pocket solutions without handles on the front.

Clip-on panels and ceiling integration profile for wall and ceiling installation.

Technical product information

You will find all of the necessary ordering information for the Hawa Junior 100 on the following pages.

Hawa Junior 100 Z

see page 8

Hawa Junior 100 B

see page 18

Hawa Junior 100 Z Pocket

see page 13

Hawa Junior 100 B Pocket

see page 24

Highlight

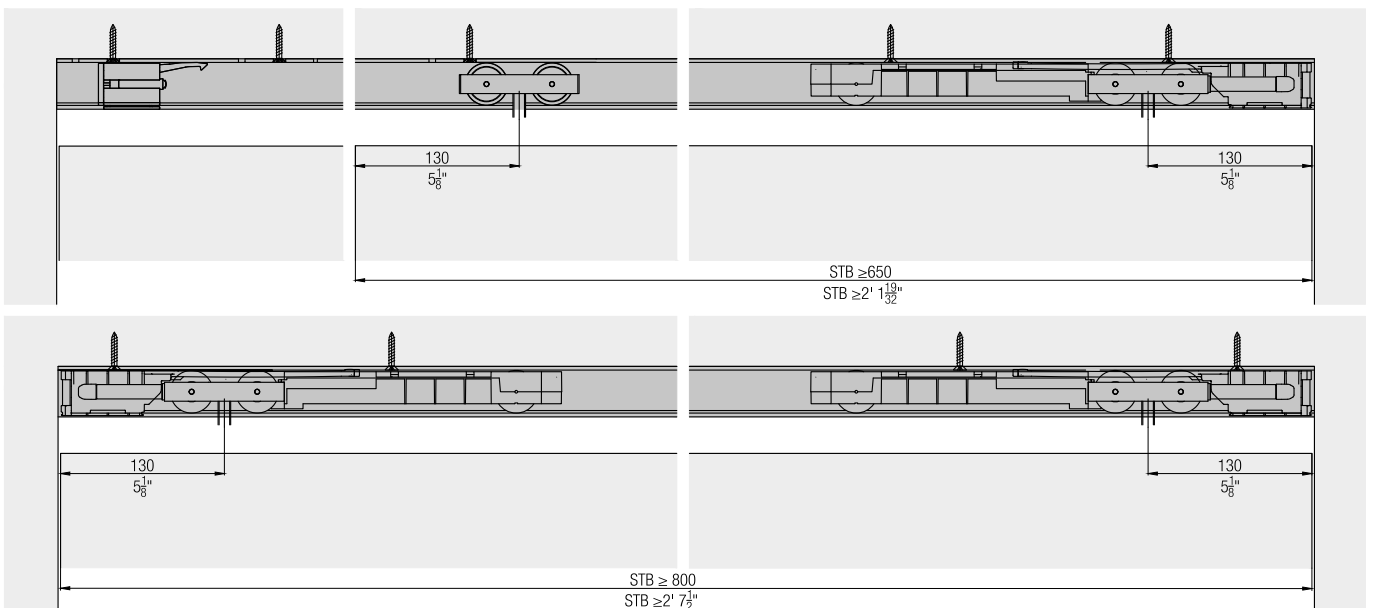

The new SoftMove 100 magnetic soft closing mechanism

Completely integrated into the running track, the SoftMove decelerates sliding doors and draws them into their final position.







Fitting for top-running wooden doors up to 100 kg (220 lbs.), with surface mounted running track. Optionally with soft and self closing mechanism. Wall or ceiling mounting.

Product highlights

-  **Comfort** Accessible opening and soft and self closing at both sides from door widths of 800 mm (2'7 1/2")
-  **Flexibility** Running tracks for wall and ceiling mounting with integrated clip-on system
-  **Security** Performance guarantee: 15 years for private use and 7 years for commercial use on incomparably low opening forces of max. 22 N

Technical specifications

-  Max. 100 kg (220 lbs.)
-  Max. 4000 mm (13'1 15/32")
-  Max. 3000 mm (9'10 1/8")
-  35–80 mm (1 3/8" to 3 5/32")

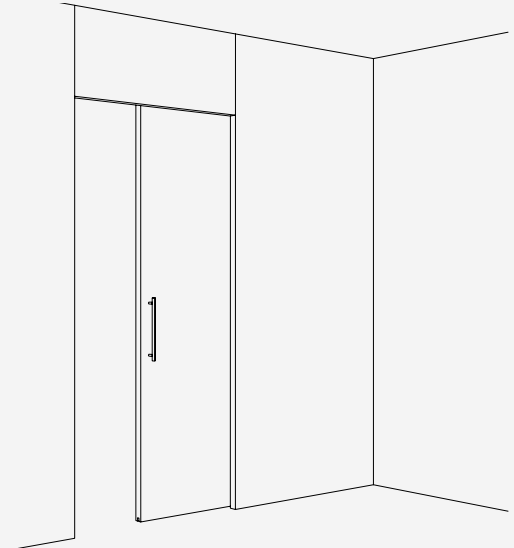



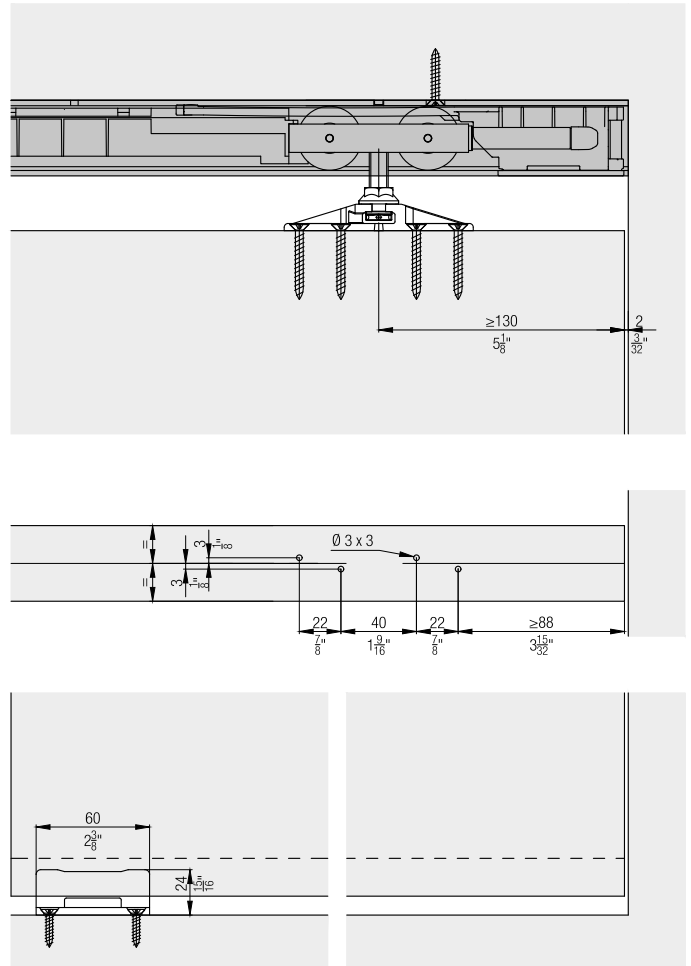
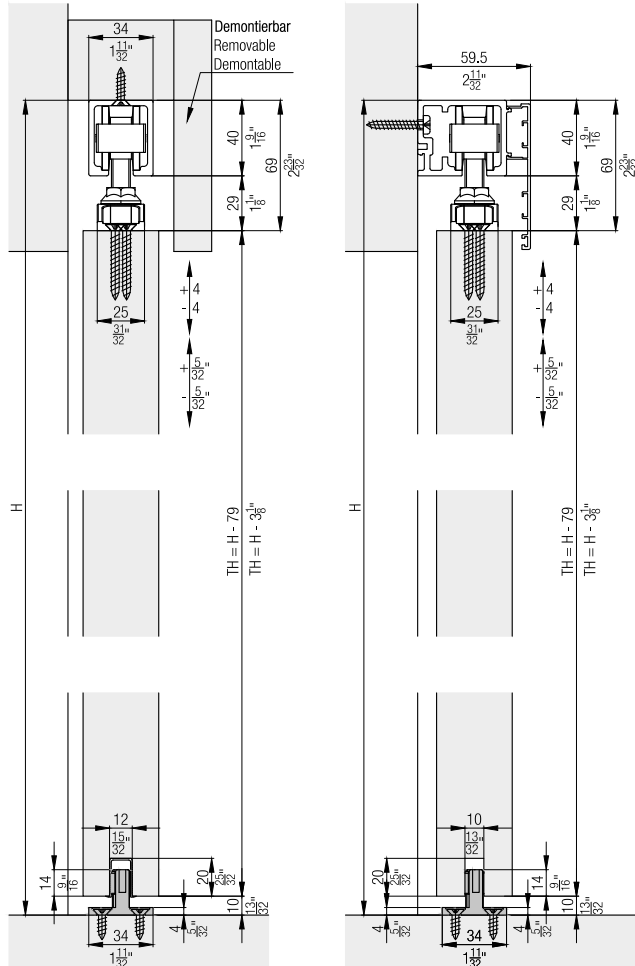

Installation examples



Set for 1 wooden door up to 100 kg (220 lbs.)

	No.
Hawa Junior 100 Z, for 1 door	30151



Set consisting of:

		30151	No.
	Two-way suspension plate	2	11002
	Set with suspension bolts M10, hexagon nuts, screws and buffer	1	13525
	Bottom guide, zero tolerance, groove width 10 mm (13/32"), plastic black	1	14427
	Vertical adjustment pin	1	10795

Set for 1 wooden door, with running gears and magnetic soft closing mechanism

	No.
Hawa Junior 100, 2 running gears, for 1 door	30064
Hawa Junior 100, 1 running gear, 1 SoftMove 100 with running gear and stopper, for 1 door	30149
Hawa Junior 100, 2 SoftMove 100 with running gear and stopper, for 1 door	30150

Set consisting of:

		30064	30149	30150	No.
	Running gear, 2-wheeled, M10, ball bearing	2	1		30137
	Soft close SoftMove 100, with running gear, stopper and cover, premounted		1	2	30509



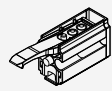
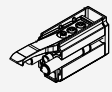

Accessories for set 30064/30149

		No.
	Stopper Hawa Junior 80/100, with adjustable retention spring	30138
	SoftStop Hawa Junior 80/100, with adjustable retention spring	27771

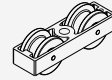
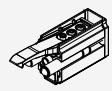

Complete set for 1 wooden door, with SoftMove and/or SoftStop

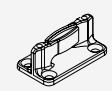
	No.
Hawa Junior 100 Z / Z Pocket, with 2 SoftStop, for 1 door	30237
Hawa Junior 100 Z / Z Pocket with 1 soft close SoftMove 100 and 1 SoftStop, for 1 door	30242
Hawa Junior 100 Z / Z Pocket with 2 soft close SoftMove 100, for 1 door	30244

Set consisting of:

		30237	30242	30244	No.
	Running gear, 2-wheeled, M10, ball bearing	2	1		30137
	SoftStop Hawa Junior 80/100, with adjustable retention spring	2	1		27771
	Two-way suspension plate	2	2	2	11002
	Set with suspension bolts M10, hexagon nuts, screws and buffer	1	1	1	13525
	Bottom guide, zero tolerance, groove width 10 mm (13/32"), plastic, black	1	1	1	14427
	Vertical adjustment pin	1	1	1	10795
	Soft close SoftMove 100, with running gear, stopper and cover, premounted		1	2	30509

Running tracks

		mm (inch)	No.
	Running track, aluminum, anodized, pre-drilled	1,400 (4' 7 1/8 ")	10189
		1,600 (5' 3 ")	10190
		1,800 (5' 10 7/8 ")	10191
		2,000 (6' 6 3/4 ")	10192
		2,200 (7' 2 5/8 ")	10193
		2,500 (8' 2 7/16")	10194
		3,000 (9' 10 1/8 ")	18532
		4,000 (13' 1 15/32")	18533
		6,000 (19' 8 7/32")	10186
		cut to size	10188
	Running track, wall mounting, aluminum, anodized, pre-drilled	2,000 (6' 6 3/4 ")	27673
		2,500 (8' 2 7/16")	30323
		3,000 (9' 10 1/8 ")	27672
		4,000 (13' 1 15/32")	30324
		6,000 (19' 8 7/32")	27671
		cut to size	27695
	Running track, ceiling mounting, aluminum, anodized, pre-drilled	2,000 (6' 6 3/4 ")	27677
		2,500 (8' 2 7/16")	30320
		3,000 (9' 10 1/8 ")	27676
		4,000 (13' 1 15/32")	30321
		6,000 (19' 8 7/32")	27675
		cut to size	27696

Guide tracks

		mm (inch)	No.
	Guide track, for groove mounting, plastic, 10-piece set	1,300 (4' 3 3/16")	14540

Panels



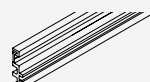

		mm (inch)	No.
	Clip-on panel to running track, aluminum, anodized	2,000 (6' 6 3/4 ")	27685
		2,500 (8' 2 7/16")	30331
		3,000 (9' 10 1/8 ")	27684
		4,000 (13' 1 15/32")	30332
		6,000 (19' 8 7/32")	27683
		cut to size	27697

Spacer tracks

		mm (inch)	No.
	Spacer track, for wall mounting, plastic, gray	2000 (6' 6 3/4")	057.3054.200
		cut to size	057.3054.990





Panel end component set, 59 mm (2 5/16"), aluminum

		No.
Panel end component set, left, 59 mm (2 5/16"), anodized		30141
Panel end component set, right, 59 mm (2 5/16"), anodized		30142





		30141	30142	No.
Set consisting of:				
	Panel end component Z, 59 mm (2 5/16"), left, aluminum, anodized	1		30038
	Bracker connector, steel, zinc-plated	2	2	057.3051.101
	Screw, M4x2.6 mm, steel, zinc-plated	4	4	011.0101.171
	Panel end component Z, 59 mm (2 5/16"), right, aluminum, anodized		1	30040

Panel end component set, 66 mm (2 19/32"), aluminum

	No.
Panel end component set, left, 66 mm (2 19/32"), anodized	30143
Panel end component set, right, 66 mm (2 19/32"), anodized	30144

		30143	30144	No.
Set consisting of:				
	Panel end component Z, 66 mm (2 19/32"), left, aluminum, anodized	1		30037
	Bracker connector, steel, zinc-plated	2	2	057.3051.101
	Screw, M4x2.6 mm, steel, zinc-plated	4	4	011.0101.171
	Panel end component Z, 66 mm (2 19/32"), right, aluminum, anodized		1	30039

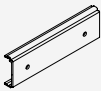
Accessories

	No.
	Bottom door stopper, with centering, stainless steel look 21473
	Bottom door stopper, with centering, chrome-plated, matt 20773
	Clip component for wooden and aluminium panel, every 500 mm (1'7 11/16"), aluminium, pre-drilled 057.3117.001
	Hawa SoundEX for Hawa Junior 80, includes fixing parts for running track 19589
	Bottom guide, rattle proof, groove width 10 mm (13/32"), plastic, black, 10-piece set 25958

Further mounting examples

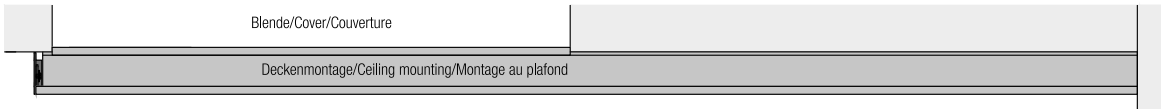
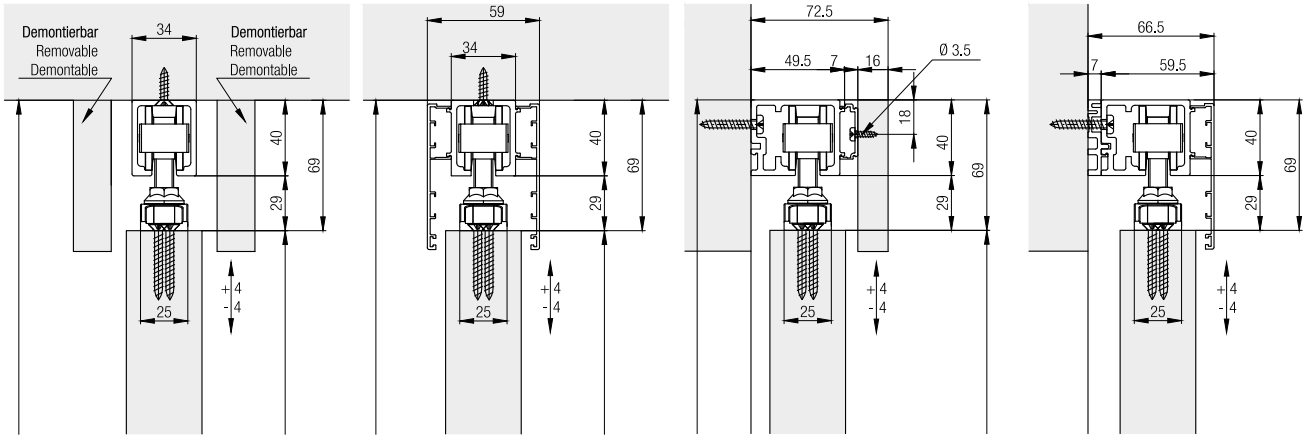

Calculation of clip-on panels

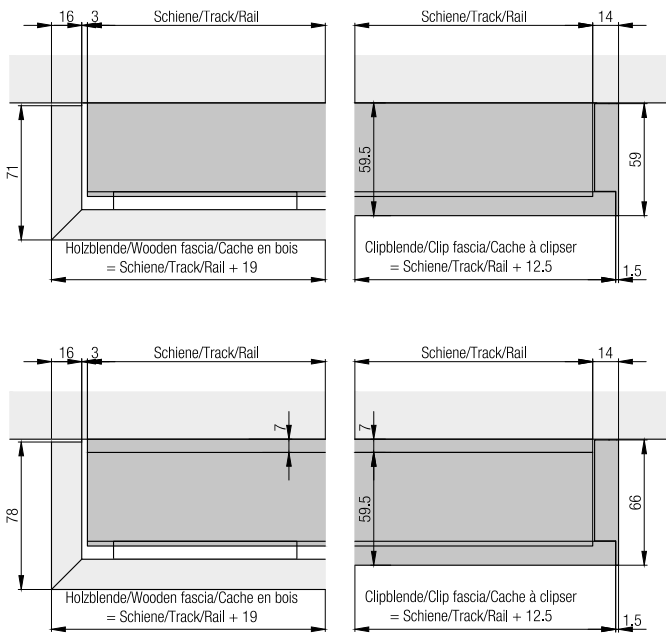

Hawa Confort 120

The convenient solution for inadequate fastening options in brittle sub-floors or in the area of floor heating. This bottom guide is mounted on the wall.

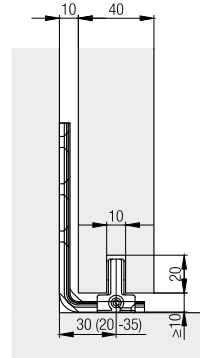

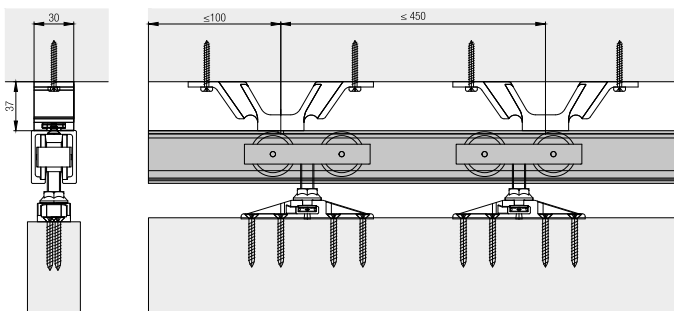

Hawa SoundEx

Contains the transmission of structure-borne noise from a sliding system to the building.







Fitting for top-running wooden doors up to 100 kg (220 lbs.), with surface mounted running track. Optionally with soft and self closing mechanism. Ceiling mounting. Wall pocket solution.

Product highlights

-  **Comfort** Accessible opening and soft and self closing at both sides from door widths of 800 mm (2'7 1/2")
-  **Productivity** Easy height adjustment via both suspensions and convenient depth adjustment of the installed door
-  **Security** Performance guarantee: 15 years for private use and 7 years for commercial use on incomparably low opening forces of max. 22 N

Technical specifications

-  Max. 100 kg (220 lbs.)
-  Max. 4000 mm (13'1 15/32")
-  Max. 1500 mm (4'11 1/16")
-  35–80 mm (1 3/8" to 3 5/32")

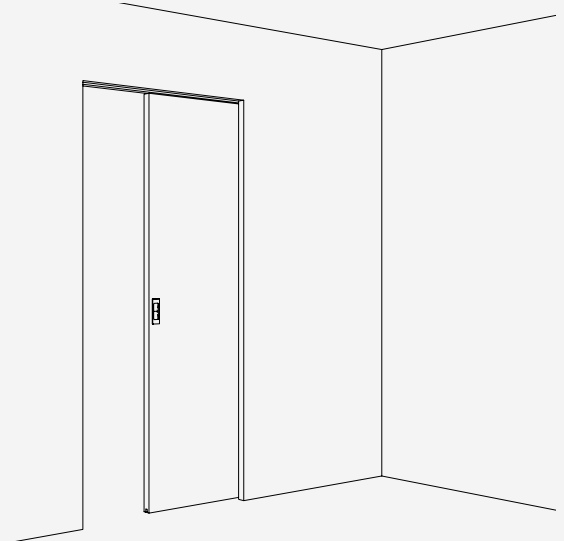



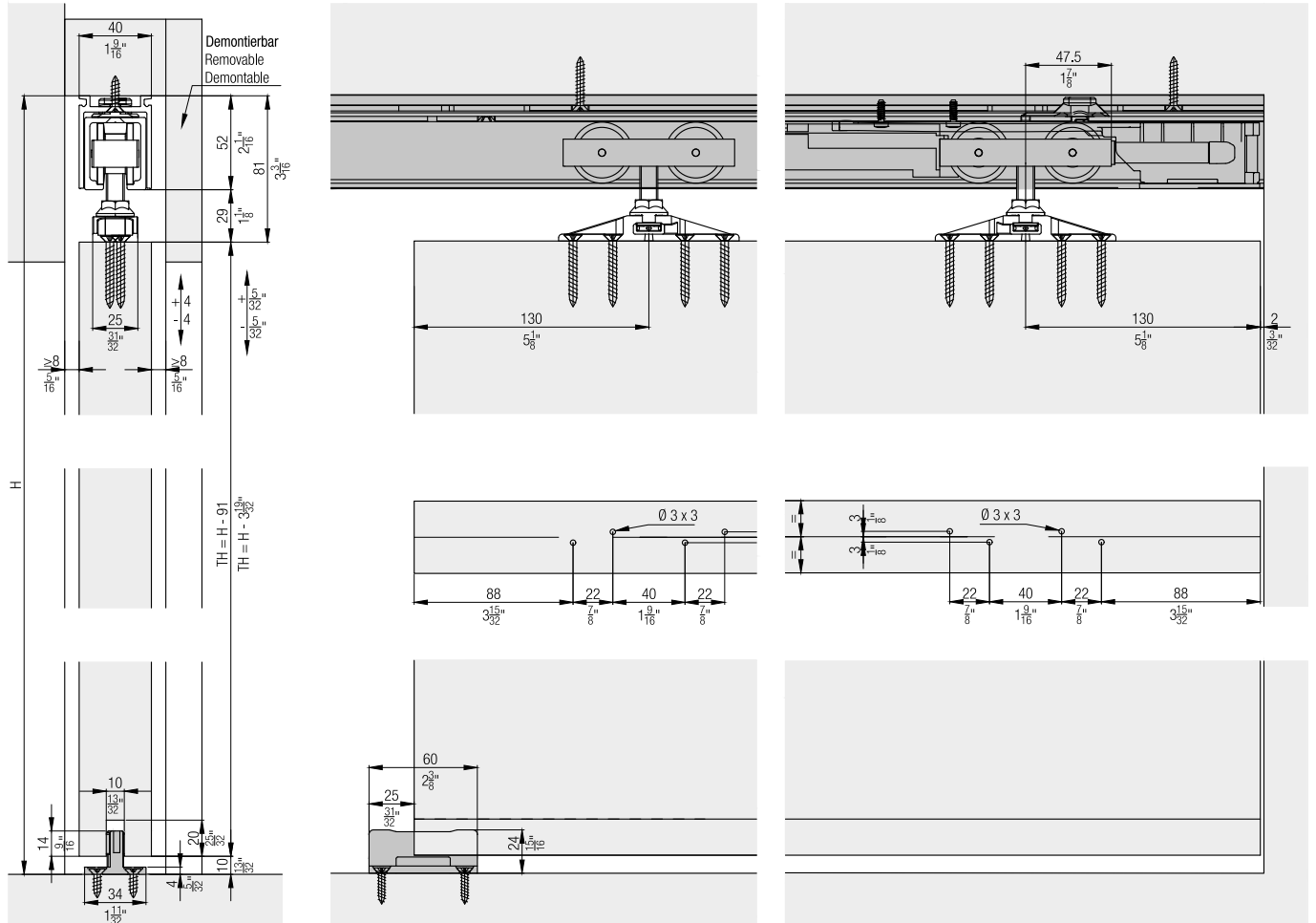

Installation examples



Set for 1 wooden door up to 100 kg (220 lbs.)

	No.
Hawa Junior 100 Z, for 1 door	30151



Set consisting of:

		30151	No.
	Two-way suspension plate	2	11002
	Set with suspension bolts M10, hexagon nuts, screws and buffer	1	13525
	Bottom guide, zero tolerance, groove width 10 mm (13/32"), plastic black	1	14427
	Vertical adjustment pin	1	10795



Set for 1 wooden door, with running gears and magnetic soft closing mechanism

	No.
Hawa Junior 100, 2 running gears, for 1 door	30064
Hawa Junior 100, 1 running gear, 1 SoftMove 100 with running gear and stopper, for 1 door	30149
Hawa Junior 100, 2 SoftMove 100 with running gear and stopper, for 1 door	30150

Set consisting of:

		30064	30149	30150	No.
	Running gear, 2-wheeled, M10, ball bearing	2	1		30137
	Soft close SoftMove 100, with running gear, stopper and cover, premounted		1	2	30509

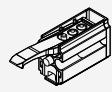
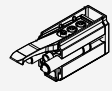



Accessories for set

		No.
	Stopper Hawa Junior 80/100, with adjustable retention spring	30138
	SoftStop Hawa Junior 80/100, with adjustable retention spring	27771
	Spring loaded stopper Hawa Junior 80/100	25370

Complete set for 1 wooden door, with Softstop and/or spring stop

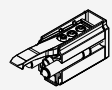
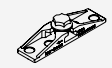
	No.
Hawa Junior 100 Z / Z Pocket, with 2 SoftStop, for 1 door	30237
Hawa Junior 100 Z / Z Pocket, with 1 SoftStop and 1 spring loaded stopper, for 1 door	30239

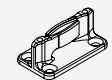
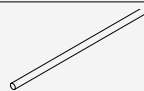





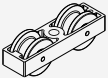

Set consisting of:

		30237	30239	No.
	Running gear, 2-wheeled, M10, ball bearing	2	2	30137
	SoftStop Hawa Junior 80/100, with adjustable retention spring	2	1	27771
	Two-way suspension plate	2	2	11002
	Set with suspension bolts M10, hexagon nuts, screws and buffer	1	1	13525
	Bottom guide, zero tolerance, groove width 10 mm (13/32"), plastic black	1	1	14427
	Vertical adjustment pin	1	1	10795
	Spring loaded stopper Hawa Junior 80/100		1	25370

Complete set for 1 wooden door, with SoftMove and/or SoftStop

	No.
Hawa Junior 100 Z / Z Pocket with 1 soft close SoftMove 100 and 1 SoftStop, for 1 door	30242
Hawa Junior 100 Z / Z Pocket with 1 soft close SoftMove 100 and 1 spring loaded stopper, for 1 door	30243
Hawa Junior 100 Z / Z Pocket with 2 soft close SoftMove 100, for 1 door	30244

Set consisting of:

	30242	30243	30244	No.
 Running gear, 2-wheeled, M10, ball bearing	1	1		30137
 Soft close SoftMove 100, with running gear, stopper and cover, premounted	1	1	2	30509
 SoftStop Hawa Junior 80/100, with adjustable retention spring	1			27771
 Two-way suspension plate	2	2	2	11002
 Set with suspension bolts M10, hexagon nuts, screws and buffer	1	1	1	13525
 Bottom guide, zero tolerance, groove width 10 mm (13/32"), plastic, black	1	1	1	14427
 Vertical adjustment pin	1	1	1	10795
 Spring loaded stopper Hawa Junior 80/100		1		25370

Running tracks

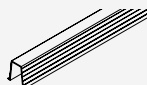

	mm (inch)	No.
 Running track, aluminum, anodized, pre-drilled	1,400 (4' 7 1/8 ")	10189
	1,600 (5' 3 ")	10190
	1,800 (5' 10 7/8 ")	10191
	2,000 (6' 6 3/4 ")	10192
	2,200 (7' 2 5/8 ")	10193
	2,500 (8' 2 7/16 ")	10194
	3,000 (9' 10 1/8 ")	18532
	cut to size	10188

Guide tracks

	mm (inch)	No.
 Guide track, for groove mounting, plastic, 10-piece set	1,300 (4' 3 3/16 ")	14540

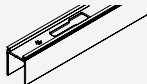

Assembly set, up to 2000 mm (6'6 3/4")

	No.
Set for mountable and demountable running track	25207

	mm (inch)	25207	No.
 Retainer profile with a bayonet lock, aluminum, anodized	2,035 (6'8 1/8 ")	1	25212
 Small parts to retainer profile, 6-piece set		1	25520

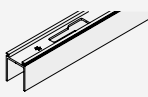

Assembly set, up to 2500 mm (8'2 7/16")

		No.
Set for mountable and demountable running track		25371

		mm (inch)	25371	No.
Set consisting of:				
	Retainer profile with a bayonet lock, aluminum, anodized	2535 (8'3 13/16")	1	25443
	Small parts to retainer profile, 7-piece set		1	25521

Assembly set, up to 3000 mm (9'10 1/8")

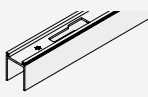
		No.
Set for mountable and demountable running track		25441

		mm (inch)	25441	No.
Set consisting of:				
	Retainer profile with a bayonet lock, aluminum, anodized	3035 (9'11 1/2")	1	25444
	Small parts to retainer profile, 9-piece set		1	25522

Panels

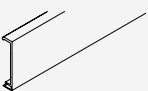
		mm (inch)	No.
	Clip-on panel, for fascia mounting, aluminum, anodized	2000 (6'6 3/4")	25445
		cut to size	27693

Accessories

		No.
	Bottom guide, rattle proof, groove width 10 mm (13/32"), plastic, black, 10-piece set	25958

Further mounting examples

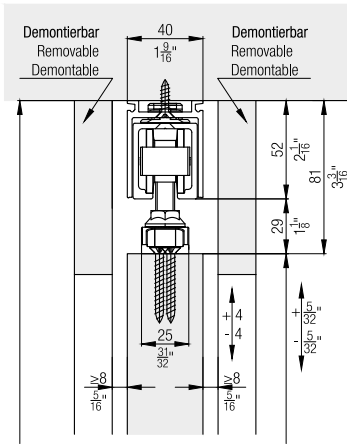

Facing for the retainer profile

The optional clip-on panel made of aluminum can be clipped onto the retainer profile without additional fixing components. For invisible fastening of the lintel panelling, there is the option of covering the clip panel on site, using panels up to 40 mm (1 9/16") thick.

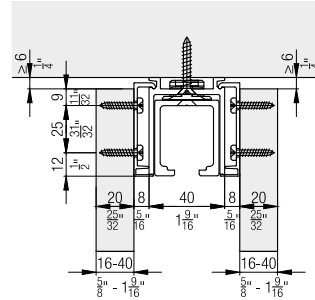

Calculation of running track length

The length of the running track must be shorter than the diagonal clearance (P2) by 80 mm (3 5/32").

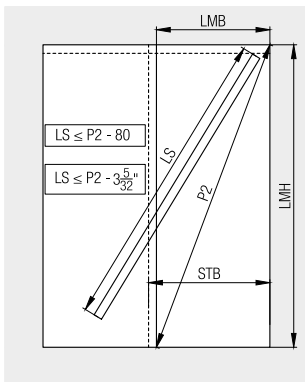

LMB = inside clearance
LMH = inside height
STB = sliding door width
P2 = diagonal clearance
LS = running track

Spring stop

The specially developed spring stop for ejecting the door is integrated into the running track without visible fittings on the door edge.

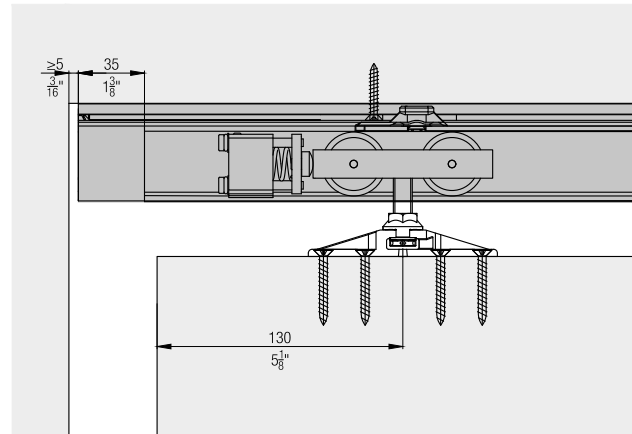

Calculation of door width

The following factors affect the calculation of the width of the sliding door:

- Open or closed guide groove
- Construction with or without spring stop (25370)

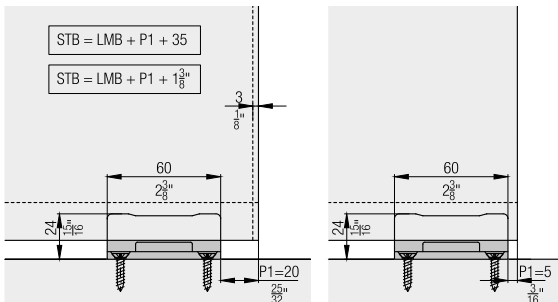

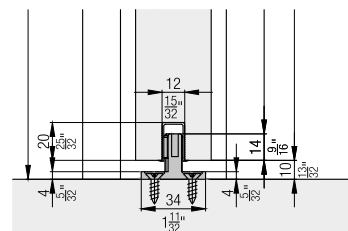

Bottom guide with guide track







Fitting for top-running wooden doors up to 100 kg (220 lbs.), with surface mounted running track or running track flush with the ceiling. Optionally with soft and self closing mechanism. Wall or ceiling mounting.

Product highlights

-  **Comfort** Accessible opening and soft and self closing at both sides from door widths of 800 mm (2'7 1/2")
-  **Flexibility** Running tracks for wall and ceiling mounting with integrated clip-on system
-  **Security** Performance guarantee: 15 years for private use and 7 years for commercial use on incomparably low opening forces of max. 22 N

Technical specifications

-  Max. 100 kg (220 lbs.)
-  Max. 4000 mm (13'1 15/32")
-  Max. 3000 mm (9'10 1/8")
-  35–80 mm (1 3/8" to 3 5/32")

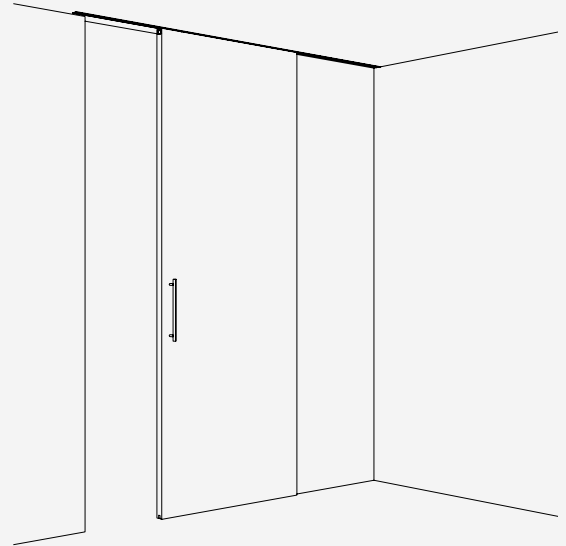

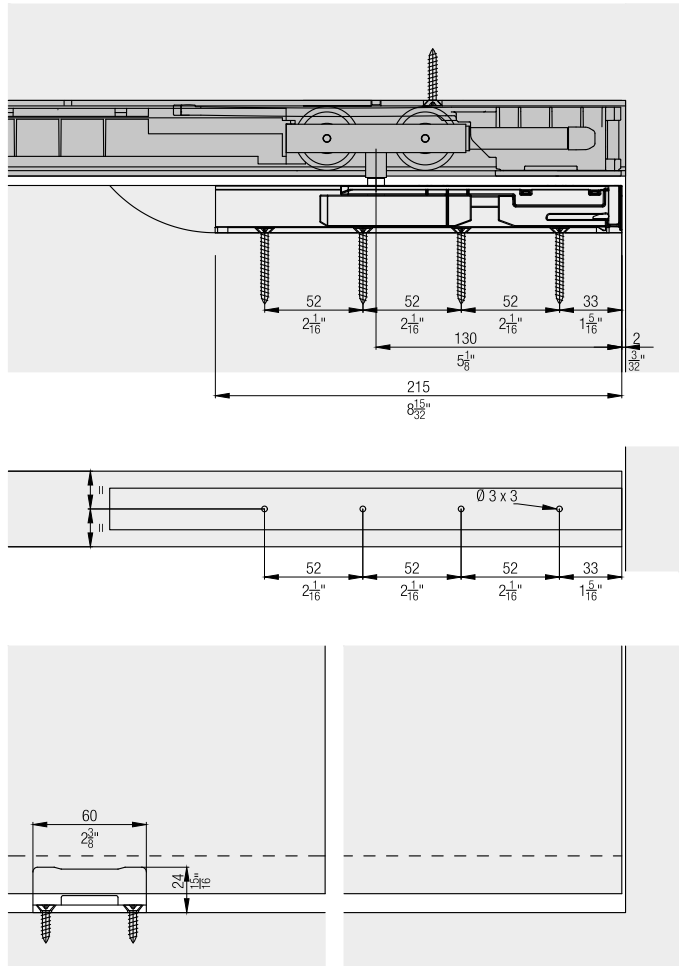
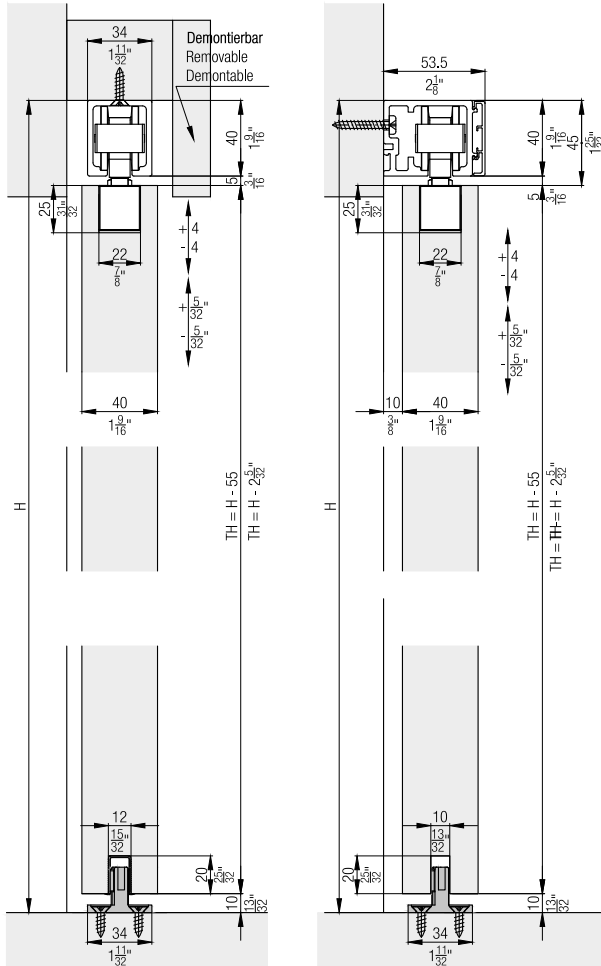

Installation examples



Set for 1 wooden door up to 100 kg (220 lbs.)

	No.
Hawa Junior 100 B, for 1 door	30152
Hawa Junior 100 B, +20 mm, for 1 door	30153

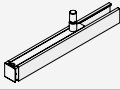

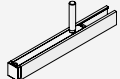
Set consisting of:

		30152	30153	No.
	Suspension profile, plate with screw M10	2		24246
	Bottom guide, zero tolerance, groove width 10 mm (13/32\"), plastic black	1	1	14427
	Screw-on rubber door stop	1	1	10629
	Suspension profile, plate, with 20 mm longer screw M10, ceiling integration		2	24846

Set for 1 wooden door, with running gears and magnetic soft closing mechanism

	No.
Hawa Junior 100, 2 running gears, for 1 door	30064
Hawa Junior 100, 1 running gear, 1 SoftMove 100 with running gear and stopper, for 1 door	30149
Hawa Junior 100, 2 SoftMove 100 with running gear and stopper, for 1 door	30150

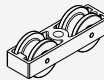
Set consisting of:

		30064	30149	30150	No.
	Running gear, 2-wheeled, M10, ball bearing	2	1		30137
	Soft close SoftMove 100, with running gear, stopper and cover, premounted		1	2	30509

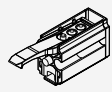
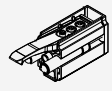

Accessories for set

		No.
	Stopper Hawa Junior 80/100, with adjustable retention spring	30138
	SoftStop Hawa Junior 80/100, with adjustable retention spring	27771

Complete set for 1 wooden door, with SoftMove and/or SoftStop

	No.
Hawa Junior 100 B, with 2 SoftStop, for 1 door	30225
Hawa Junior 100 B, with 1 soft close SoftMove 100 and 1 SoftStop, for 1 door	30227
Hawa Junior 100 B, with 2 soft close SoftMove 100, for 1 door	30228

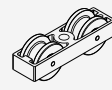
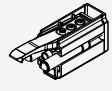
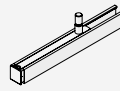

Set consisting of:

		30225	30227	30228	No.
	Running gear, 2-wheeled, M10, ball bearing	2	1		30137
	SoftStop Hawa Junior 80/100, with adjustable retention spring	2	1		27771
	Suspension profile, plate with screw M10	2	2	2	24246
	Bottom guide, zero tolerance, groove width 10 mm (13/32\"), plastic, black	1	1	1	14427
	Soft close SoftMove 100, with running gear, stopper and cover, premounted		1	2	30509



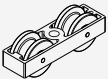
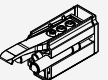
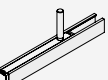
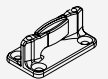

**Complete set for 1 wooden door,
with 20 mm (25/32") longer suspension bolt**

	No.
Hawa Junior 100 B, with 20 mm longer suspension bolt, 2 SoftStop, for 1 door	30230
Hawa Junior 100 B, with 20 mm longer suspension bolt, 1 soft close SoftMove 100 and 1 SoftStop, for 1 door	30232
Hawa Junior 100 B, with 20 mm longer suspension bolt, 2 soft close SoftMove 100, for 1 door	30233

Set consisting of:

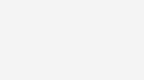
		30230	30232	30233	No.
	Running gear, 2-wheeled, M10, ball bearing	2	1		30137
	SoftStop Hawa Junior 80/100, with adjustable retention spring	2	1		27771
	Suspension profile, plate, with 20 mm longer screw M10, ceiling integration	2	2	2	24846
	Bottom guide, zero tolerance, groove width 10 mm (13/32"), plastic black	1	1	1	14427
	Soft close SoftMove 100, with running gear, stopper and cover, premounted		1	2	30509

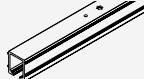
Running tracks

		mm (inch)	No.
	Running track, aluminum, anodized, pre-drilled	1,400 (4' 7 1/8 ")	10189
		1,600 (5' 3 ")	10190
		1,800 (5' 10 7/8 ")	10191
		2,000 (6' 6 3/4 ")	10192
		2,200 (7' 2 5/8 ")	10193
		2,500 (8' 2 7/16 ")	10194
		3,000 (9' 10 1/8 ")	18532
		4,000 (13' 1 15/32 ")	18533
		6,000 (19' 8 7/32 ")	10186
		cut to size	10188
	Running track, aluminum, stainless steel look, brushed, pre-drilled	4,000 (13' 1 15/32 ")	20005
		6,000 (19' 8 7/32 ")	20004
		cut to size	20006
	Running track, wall mounting, aluminum, anodized, pre-drilled	2,000 (6' 6 3/4 ")	27673
		2,500 (8' 2 7/16 ")	30323
		3,000 (9' 10 1/8 ")	27672
		4,000 (13' 1 15/32 ")	30324
		6,000 (19' 8 7/32 ")	27671
		cut to size	27695
	Running track, ceiling mounting, aluminum, anodized, pre-drilled	2,000 (6' 6 3/4 ")	27677
		2,500 (8' 2 7/16 ")	30320
		3,000 (9' 10 1/8 ")	27676
		4,000 (13' 1 15/32 ")	30321
		6,000 (19' 8 7/32 ")	27675
		cut to size	27696
	Running track, ceiling integration, aluminum, anodized, pre-drilled	2,500 (8' 2 7/16 ")	27664
		4,000 (13' 1 15/32 ")	27663
		6,000 (19' 8 7/32 ")	30325
		cut to size	27665

Guide tracks

		mm (inch)	No.
	Guide track, for groove mounting, plastic, 10-piece set	1300 (4'3 3/16")	14540

Panels

		mm (inch)	No.
	Clip-on panel to running track, aluminum, anodized	2000 (6'6 3/4")	27689
		3000 (9'10 1/8")	27688
		6000 (19'8 7/32")	27687
		cut to size	27698



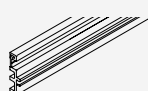

Spacer tracks

		mm (inch)	No.
	Spacer track, for wall mounting, plastic, gray	2000 (6'6 3/4")	057.3054.200
		cut to size	057.3054.990

Panel end component set, 53 mm (2 3/32"), aluminum

		No.
Panel end component set, left, 53 mm (2 3/32"), anodized		30145
Panel end component set, right, 53 mm (2 3/32"), anodized		30146





Set consisting of:

		30145	30146	No.
	Panel end component B, left, 53 mm (2 3/32"), aluminum, anodized	1		30034
	Bracker connector, steel, zinc-plated	1	1	057.3051.101
	Screw, M4x2.6 mm, steel, zinc-plated	2	2	011.0101.171
	Panel end component B, right, 53 mm (2 3/32"), aluminum, anodized		1	30036

Panel end component set, 60 mm (2 3/8"), aluminum





		No.
Panel end component set, left, 60 mm (2 3/8"), anodized		30147
Panel end component set, right, 60 mm (2 3/8"), anodized		30148

Set consisting of:

		30147	30148	No.
	Panel end component B, left, 60 mm (2 3/8"), aluminum, anodized	1		30030
	Bracker connector, steel, zinc-plated	1	1	057.3051.101
	Screw, M4x2.6 mm, steel, zinc-plated	2	2	011.0101.171
	Panel end component B, right, 60 mm (2 3/8"), aluminum, anodized		1	30035

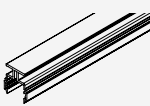
Hawa Adapto 80/100 concrete casting system, without fixed glazing

	No.
Inset profile for concrete surfaces Hawa Adapto 80, without fixed glass, 2500 mm (8'2 7/16")	20216
Inset profile for concrete surfaces Hawa Adapto 80, without fixed glass, 4000 mm (13'1 15/32")	20217

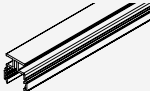
Set consisting of:		mm (inch)	20216	20217	No.
	Inset profile for concrete surfaces, without fixed glass, aluminum	2500 (8'2 7/16")	1		20087
	Polystyrene insert, without fixed glass	1000 (3'3 3/8")	2	4	19418
	Polystyrene insert, without fixed glass	500 (1'7 11/16")	1		19556
	Assembly clips, plastic, black, without fixed glass		4	5	19344
	Cover cap, without fixed glass, plastic, gray		2	2	19366
	Inset profile for concrete surfaces, without fixed glass, aluminum	4000 (13'1 15/32")		1	20088



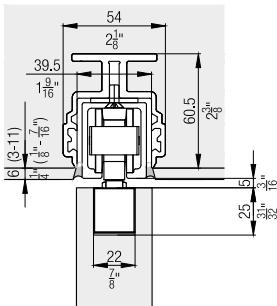

Hawa Adapto 80/100 concrete casting system

The Hawa Adapto 80/100 concrete casting system can be easily and efficiently integrated into the building shell and allows Hawa Junior 80/100 running tracks to be installed flush with the ceiling.







Assembly set for Hawa Adapto 80/100

	No.
Assembly set, with countersunk head screw, length up to 2500 mm (8'2 7/16")	22841
Assembly set, with countersunk head screw, length 2501 - 4000 mm (8'2 15/32"-13'1 15/32")	22842

Set consisting of:		22841	22842	No.
	Distance plate, plastic, 1 mm (1/32")	2	2	19398
	Distance plate, plastic, 2 mm (3/32")	2	2	19399
	Distance plate, plastic, 3 mm (1/8")	2	2	19400
	Distance plate, plastic, 5 mm (3/16")	4	4	19401
	Special countersunk screws, 6x21 mm, 10-piece set	1	2	22844

Accessories

	No.
	24957
	24956
	21473
	20773
	25958

Calculation of clip-on panels

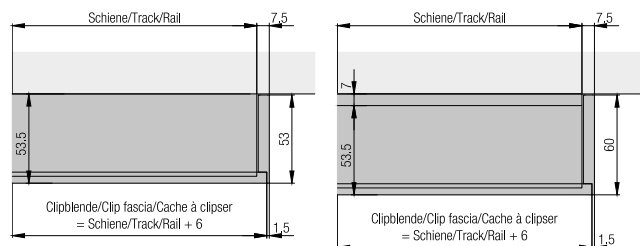

Further mounting examples

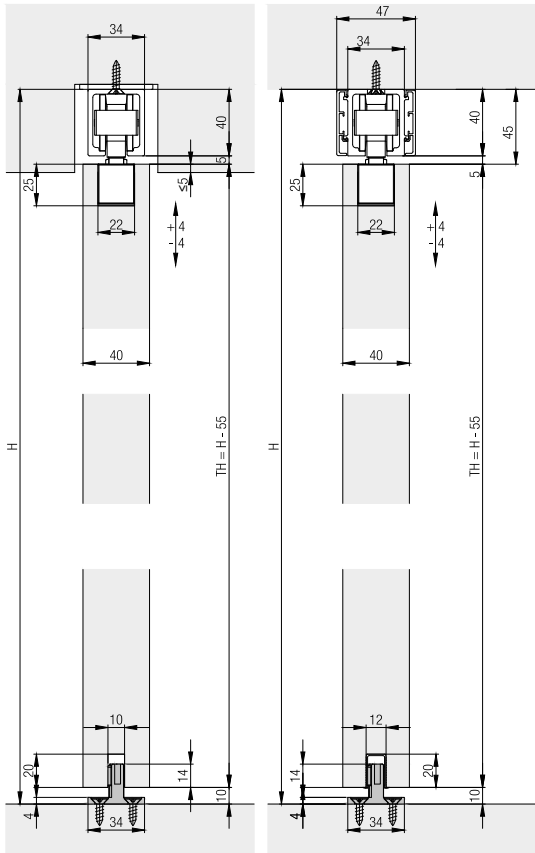

Ceiling integration

Recommendation: For systems integrated into the ceiling, provide assembly openings or front access to the system – front access of Soft Move is always mandatory.

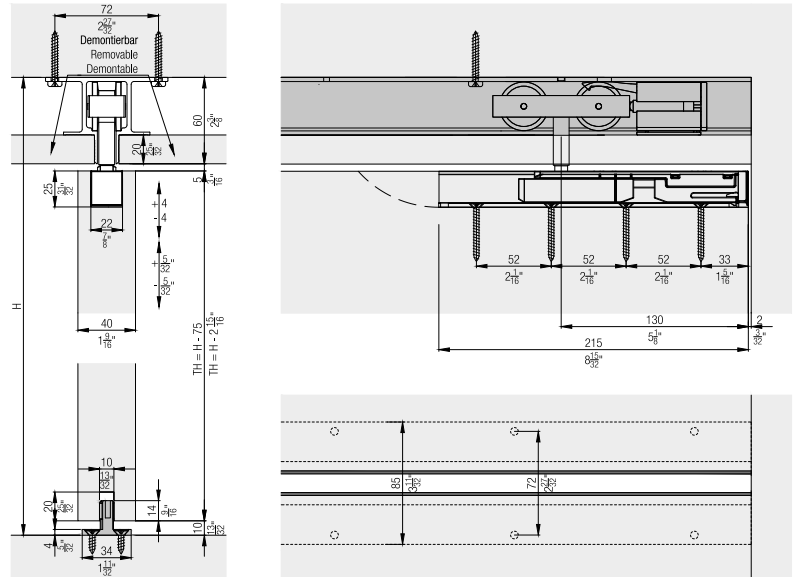

Hawa Confort 120

The convenient solution for inadequate fastening options in brittle sub-floors or in the area of floor heating. This bottom guide is mounted on the wall.

Further mounting examples with spacer track

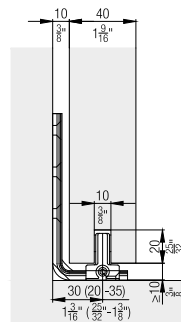
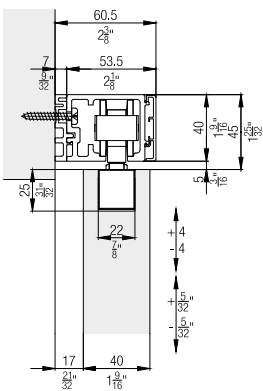

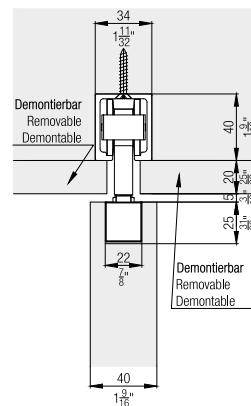

Version with 20 mm (25/32") longer hanger bolt

Thanks to the set No. 30153, the running track can be covered from below, using removable ceiling elements.







Fitting for top-running wooden doors up to 100 kg (220 lbs.), with surface mounted running track or running track flush with the ceiling. Optionally with soft and self closing mechanism. Ceiling mounting. Wall pocket solution.

Product highlights

-  **Comfort** Accessible opening and soft and self closing at both sides from door widths of 800 mm (2'7 1/2")
-  **Productivity** Easy height adjustment via both suspensions and convenient depth adjustment of the installed door
-  **Security** Performance guarantee: 15 years for private use and 7 years for commercial use on incomparably low opening forces of max. 22 N

Technical specifications

-  Max. 100 kg (220 lbs.)
-  Max. 4000 mm (13'1 15/32")
-  Max. 1500 mm (4'11 1/16")
-  35–80 mm (1 3/8" to 3 5/32")

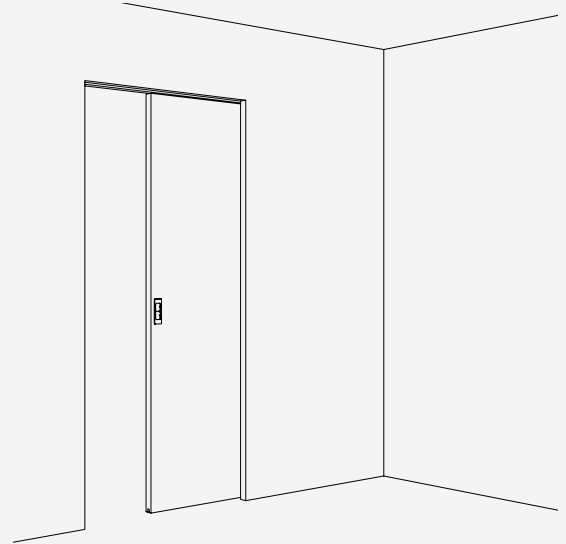

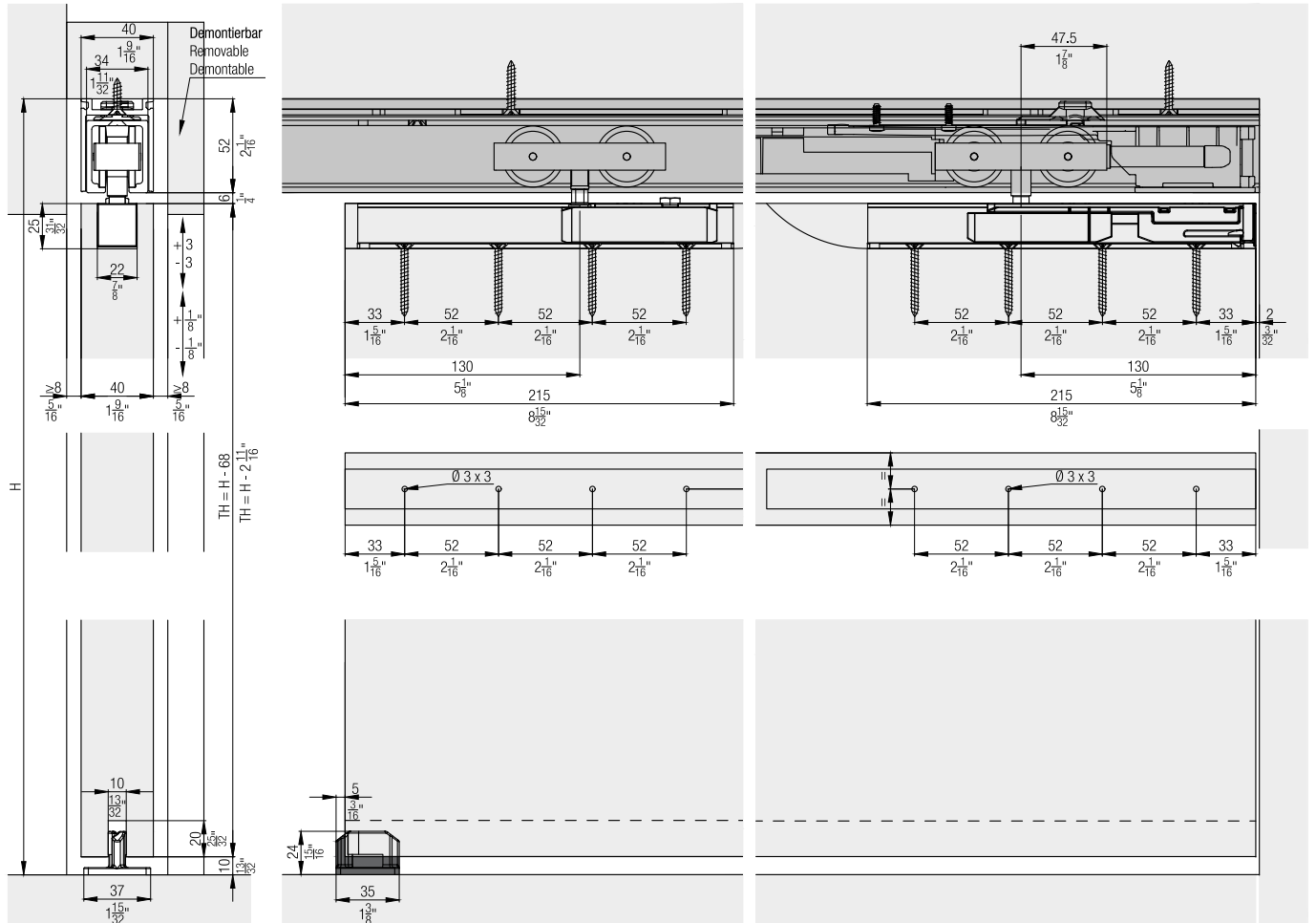

Installation examples



Set for 1 wooden door up to 100 kg (220 lbs.)

	No.
Hawa Junior 100 B Pocket, for 1 door	30154
Hawa Junior 100 B Pocket, +20 mm (+25/32"), for 1 door	30155

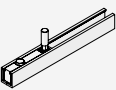
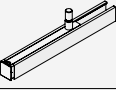
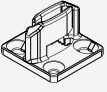

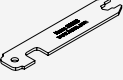
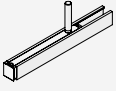
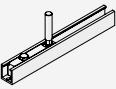
Set consisting of:

		30154	30155	No.
	Suspension profile, with plate, with suspension bolt M10, wall pocket installation	1		24323
	Suspension profile, plate with screw M10	1		24246
	Bottom guide, zero tolerance, groove width 10 mm, plastic, black	1	1	25369
	Screw-on rubber door stop	1	1	10629
	Locking wrench to suspension	1	1	10778
	Suspension profile, plate, with 20 mm longer screw M10, ceiling integration		1	24846
	Suspension profile, plate with 20 mm longer screw M10, for Pocket		1	26003

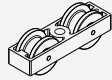

Set for 1 wooden door, with running gears and magnetic soft closing mechanism

	No.
Hawa Junior 100, 2 running gears, for 1 door	30064
Hawa Junior 100, 1 running gear, 1 SoftMove 100 with running gear and stopper, for 1 door	30149
Hawa Junior 100, 2 SoftMove 100 with running gear and stopper, for 1 door	30150

Set consisting of:

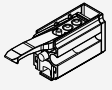
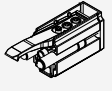

		30064	30149	30150	No.
	Running gear, 2-wheeled, M10, ball bearing	2	1		30137
	Soft close SoftMove 100, with running gear, stopper and cover, premounted		1	2	30509

Accessories for set

		No.
	Stopper Hawa Junior 80/100, with adjustable retention spring	30138
	SoftStop Hawa Junior 80/100, with adjustable retention spring	27771
	Spring loaded stopper Hawa Junior 80/100	25370



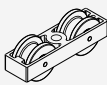
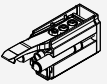
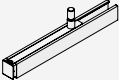
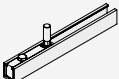
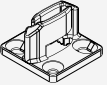
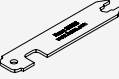

**Complete set for 1 wooden door,
with SoftStop and spring stop or SoftStop**

	No.
Hawa Junior 100 B Pocket, with 2 SoftStop, for 1 door	30248
Hawa Junior 100 B Pocket, with 1 SoftStop and 1 spring loaded stopper, for 1 door	30250

Set consisting of:			No.
	30248	30250	
 Running gear, 2-wheeled, M10, ball bearing	2	2	30137
 SoftStop Hawa Junior 80/100, with adjustable retention spring	2	1	27771
 Suspension profile, plate with screw M10	1	1	24246
 Suspension profile, with plate, with suspension bolt M10, wall pocket installation	1	1	24323
 Bottom guide, zero tolerance, groove width 10 mm, plastic, black	1	1	25369
 Locking wrench to suspension	1	1	10778
 Spring loaded stopper Hawa Junior 80/100		1	25370

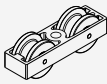
Complete set for 1 wooden door, with SoftMove and/or SoftStop

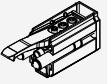
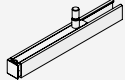
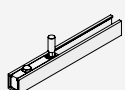
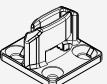
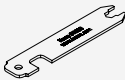

	No.
Hawa Junior 100 B Pocket, with 1 soft close SoftMove 100 and 1 SoftStop, for 1 door	30253
Hawa Junior 100 B Pocket, with 1 soft close SoftMove 100 and 1 spring loaded stopper, for 1 door	30254
Hawa Junior 100 B Pocket, with 2 soft close SoftMove 100, for 1 door	30255

Set consisting of:				No.
	30253	30254	30255	
 Running gear, 2-wheeled, M10, ball bearing	1	1		30137
 Soft close SoftMove 100, with running gear, stopper and cover, premounted	1	1	2	30509
 SoftStop Hawa Junior 80/100, with adjustable retention spring		1		27771
 Suspension profile, plate with screw M10	1	1	1	24246
 Suspension profile, with plate, with suspension bolt M10, wall pocket installation	1	1	1	24323
 Bottom guide, zero tolerance, groove width 10 mm (13/32"), plastic, black	1	1	1	25369
 Locking wrench to suspension	1	1	1	10778
 Spring loaded stopper Hawa Junior 80/100		1		25370

Complete set for 1 wooden door, with 20 mm (25/32") longer suspension bolt and SoftStop

	No.
Hawa Junior 100 B Pocket, with 20 mm longer suspension bolt, 2 SoftStop, for 1 door	30259
Hawa Junior 100 B Pocket, with 20 mm longer suspension bolt, 1 SoftStop and 1 spring loaded stopper, for 1 door	30261

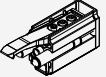
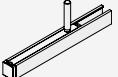
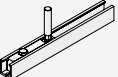
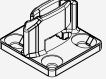
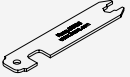



Set consisting of:

	30259	30261	No.
 Running gear, 2-wheeled, M10, ball bearing	2	2	30137
 SoftStop Hawa Junior 80/100, with adjustable retention spring	2	1	27771
 Suspension profile, plate, with 20 mm longer screw M10, ceiling integration	1	1	24846
 Suspension profile, plate with 20 mm longer screw M10, for Pocket	1	1	26003
 Bottom guide, zero tolerance, groove width 10 mm, plastic, black	1	1	25369
 Locking wrench to suspension	1	1	10778
 Spring loaded stopper Hawa Junior 80/100		1	25370

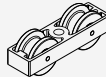

Complete set for 1 wooden door, with 20 mm (25/32") longer suspension bolt

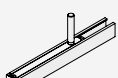
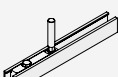
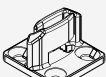
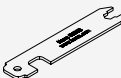
	No.
Hawa Junior 100 B Pocket, with 20 mm longer suspension bolt, 1 soft close SoftMove 100 and 1 SoftStop, for 1 door	30264
Hawa Junior 100 B Pocket, with 20 mm longer suspension bolt, 1 soft close SoftMove 100 and 1 spring loaded stopper, for 1 door	30265
Hawa Junior 100 B Pocket, with 20 mm longer suspension bolt, 2 soft close SoftMove 100, for 1 door	30266

Set consisting of:

	30264	30265	30266	No.
 Running gear, 2-wheeled, M10, ball bearing	1	1		30137
 Soft close SoftMove 100, with running gear, stopper and cover, premounted	1	1	2	30509
 SoftStop Hawa Junior 80/100, with adjustable retention spring	1			27771
 Suspension profile, plate, with 20 mm (25/32") longer screw M10, ceiling integration	1	1	1	24846
 Suspension profile, plate with 20 mm (25/32") longer screw M10, for Pocket	1	1	1	26003
 Bottom guide, zero tolerance, groove width 10 mm (13/32"), plastic, black	1	1	1	25369
 Locking wrench to suspension	1	1	1	10778
 Spring loaded stopper Hawa Junior 80/100		1		25370

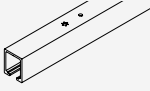
Running tracks

		mm (inch)	No.
	Running track, aluminum, anodized, pre-drilled	1,400 (4' 7 1/8 ")	10189
		1,600 (5' 3 ")	10190
		1,800 (5' 10 7/8 ")	10191
		2,000 (6' 6 3/4 ")	10192
		2,200 (7' 2 5/8 ")	10193
		2,500 (8' 2 7/16 ")	10194
		3,000 (9' 10 1/8 ")	18532
		cut to size	10188
	Running track, ceiling integration, aluminum, anodized, pre-drilled	2,500 (8' 2 7/16 ")	27664
		4,000 (13' 1 15/32 ")	27663
		6,000 (19' 8 7/32 ")	30325
		cut to size	27665



Guide tracks

		mm (inch)	No.
	Guide track, for groove mounting, plastic, 10-piece set	1300 (4' 3 3/16 ")	14540

Assembly set, up to 2000 mm (6'6 3/4")

		No.
Set for mountable and demountable running track		25207

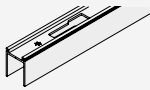

Set consisting of:

		mm (inch)	25207	No.
	Retainer profile with a bayonet lock, aluminum, anodized	2035 (6' 8 1/8 ")	1	25212
	Small parts to retainer profile, 6-piece set		1	25520

Assembly set, up to 2500 mm (8'2 7/16")

		No.
Set for mountable and demountable running track		25371

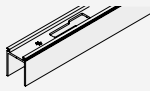

Set consisting of:

		mm (inch)	25371	No.
	Retainer profile with a bayonet lock, aluminum, anodized	2535 (8' 3 13/16 ")	1	25443
	Small parts to retainer profile, 7-piece set		1	25521

Assembly set, up to 3000 mm (9'10 1/8")

		No.
Set for mountable and demountable running track		25441

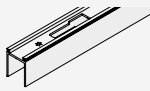
Set consisting of:

		mm (inch)	25441	No.
	Retainer profile with a bayonet lock, aluminum, anodized	3035 (9' 11 1/2 ")	1	25444
	Small parts to retainer profile, 9-piece set		1	25522

Panels

		mm (inch)	No.
	Clip-on panel, for fascia mounting, aluminum, anodized	2000 (6' 6 3/4 ")	25445
		cut to size	27693

Further mounting examples

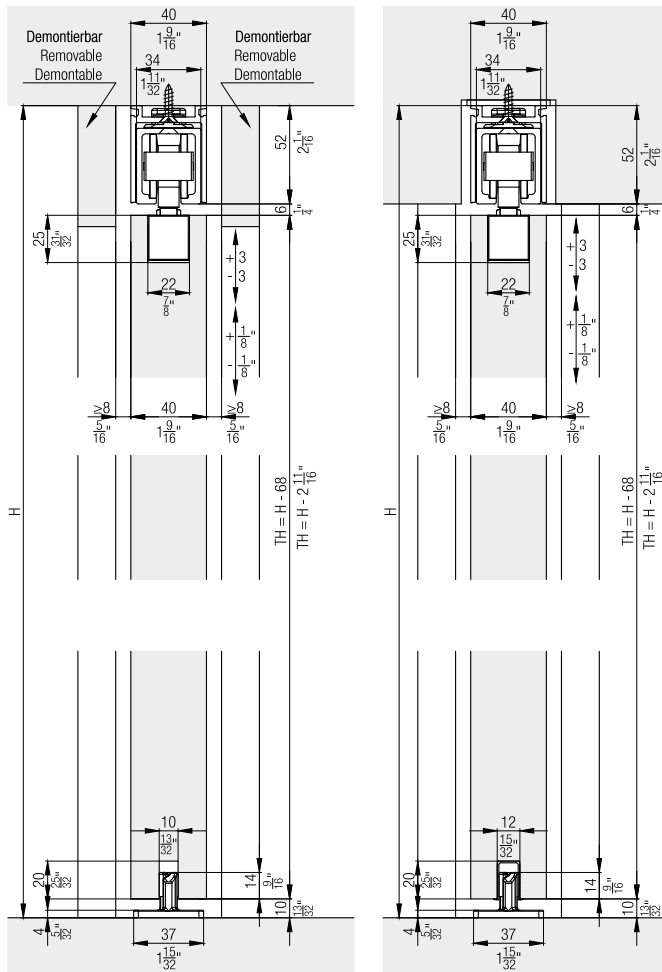

Calculation of running track length

The length of the running track must be shorter than the diagonal clearance (P2) by at least 80 mm (3 5/32").

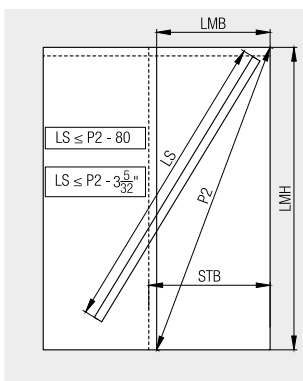

LMB = inside clearance
 LMH = inside height
 STB = sliding door width
 P2 = diagonal clearance
 LS = running track

Calculation of door width

The following factors affect the calculation of the width of the sliding door:

- Open or closed guide groove
- Construction with or without spring stop (25370)

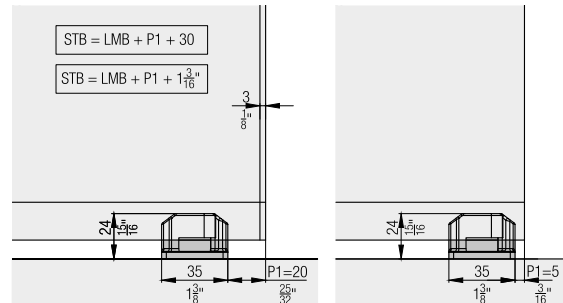

Facing for the retainer profile

The optional clip-on panel made of aluminum can be clipped onto the retainer profile without additional fixing components. For invisible fastening of the lintel panelling, there is the option of covering the clip panel on site, using panels up to 40 mm (1 9/16") thick.

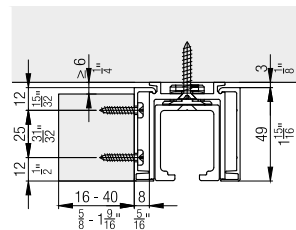

Spring stop

The specially developed spring stop for ejecting the door is integrated into the running track without visible fittings on the door edge.

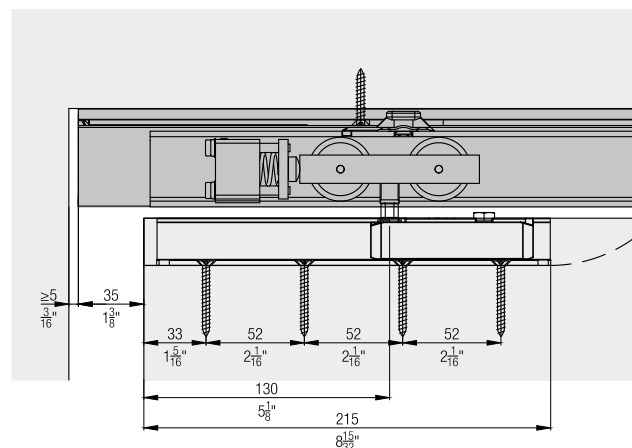

Version with 20 mm (25/32") longer hanger bolt

Thanks to the set with a longer hanger bolt, the running track can be covered from below, using removable ceiling elements.

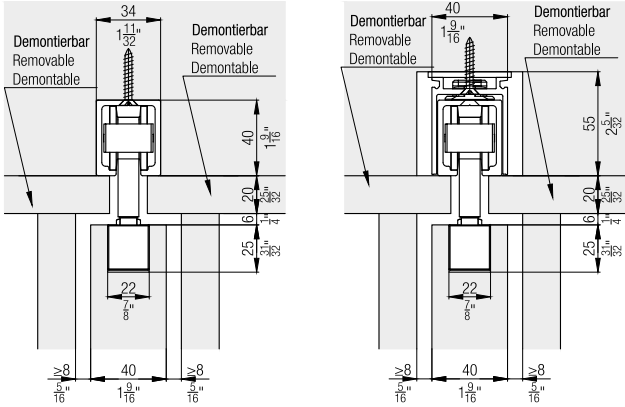



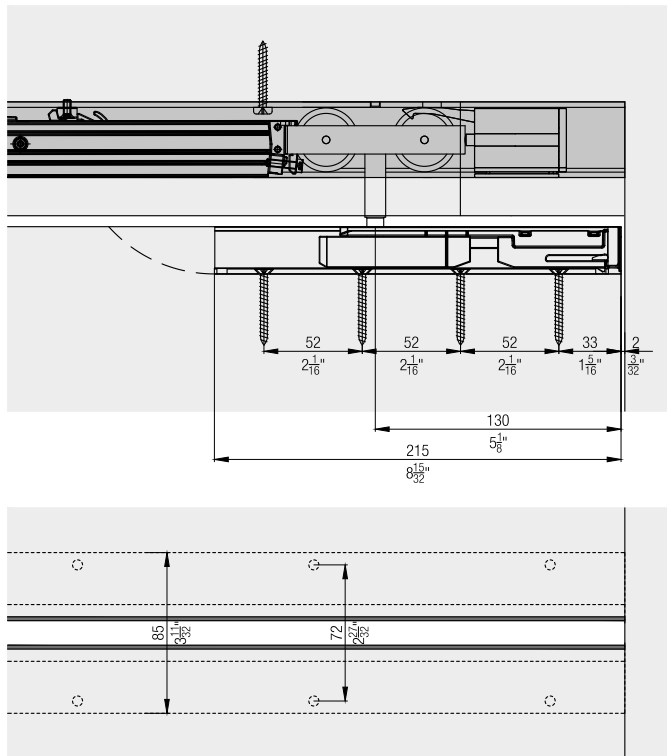
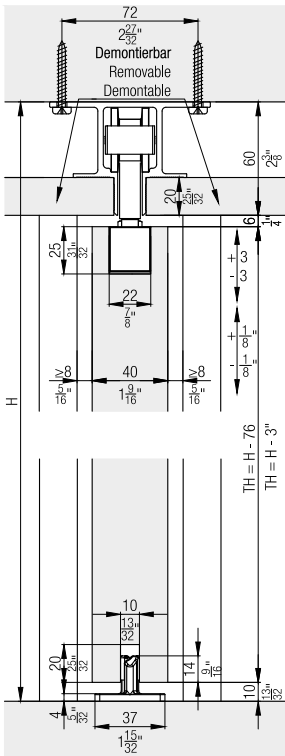

Ceiling integration

Recommendation: For systems integrated into the ceiling, provide assembly openings or front access to the system – front access of Soft Move is always mandatory.







A solution for every application: Hawa Junior diversity at a glance

System advantages

-  **Flexibility** **Wall mounting, ceiling mounting, ceiling integration or installation in wall pockets possible**
-  **Productivity** **Extremely efficient, tool-less door installation**
Quick and easy adjustment at the installed door
-  **Comfort** **Extremely smooth running, perfect soft closing mechanism and secure stopping** thanks to the continuously adjustable interlocking force of the track buffer
-  **Aesthetics** Filigree **designer cover caps** with stainless steel effect
Minimal installation height, since a gap of only 1 mm between the door and the running track is possible







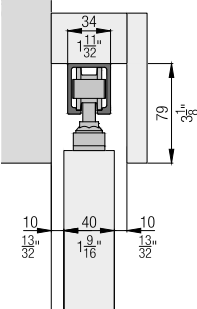
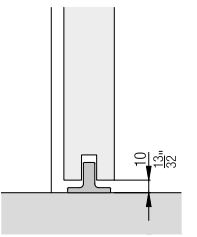

Technical specifications

-  Max. 40/80/100/
120/160/250 kg
-  Max. 4000 mm
-  Max. 3000 mm
-  35–80 mm

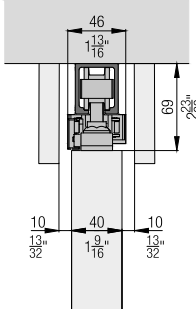
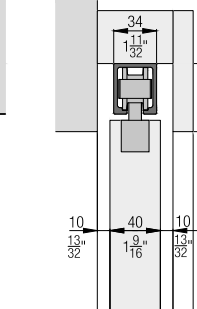
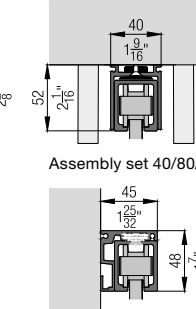
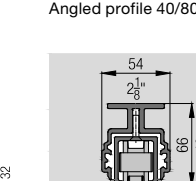
Good to know (accessories)

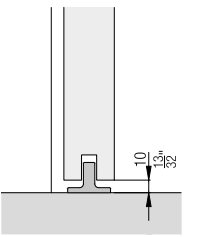
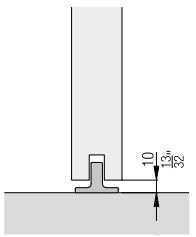
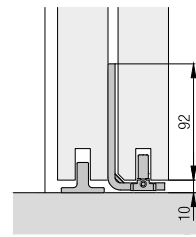
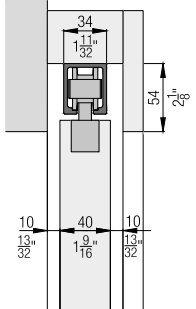
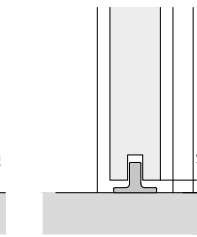
- SoftMove soft and self closing mechanism
- Lock Hawa Slide Lock
- Hawa SoundEx against structure-borne noise transmission

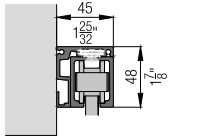
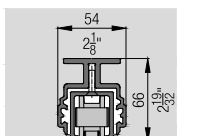
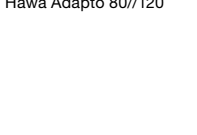
Installation examples

<p>Hawa Junior 80 Z</p> 	<p>Hawa Junior 80 Z Symmetric</p> 	<p>Hawa Junior 80 Z Telescopic (2 doors)</p> 	<p>Hawa Junior 80 B</p> 	<p>Hawa Junior 80 B Pocket</p> 	<p>Fixing</p>  <p>Assembly set 40/80//120</p>  <p>Angled profile 40/80//120</p>  <p>Hawa Adapto 80//120</p> 
					
					
<p>Product range Hawa Junior 40 Z Hawa Junior 80 Z Hawa Junior 120 A Hawa Junior 160 A Hawa Junior 250 A</p>	<p>Hawa Junior 80 Z Symmetric</p>	<p>Hawa Junior 80 Z Telescopic 4 Hawa Junior 80 Z Telescopic 2 Hawa Junior 80 Z Telescopic 3</p>	<p>Hawa Junior 40 B Hawa Junior 80 B Hawa Junior 120 B Hawa Junior 160 B Hawa Junior 250 B</p>	<p>Hawa Junior 40 B Pocket Hawa Junior 80 B Pocket Hawa Junior 120 B Pocket</p>	

Planning/execution

Further information about the product can be found on www.hawa.com.

Visit us online

At hawa.com/en/junior you will find all the relevant details about this high-quality fitting solution by Hawa Sliding Solutions. See for yourself: The new Hawa Junior 100 will win your customers over almost as easily as it moves wooden doors.

We would be happy to advise you personally. Contact us at info@hawa.com or by phone under +41 44 787 17 17.