



**fischer** 

**Light System FLS**  
Snel, stabiel  
en veelzijdig



# fischer Light System FLS.

## Lichte strut profielen FLS

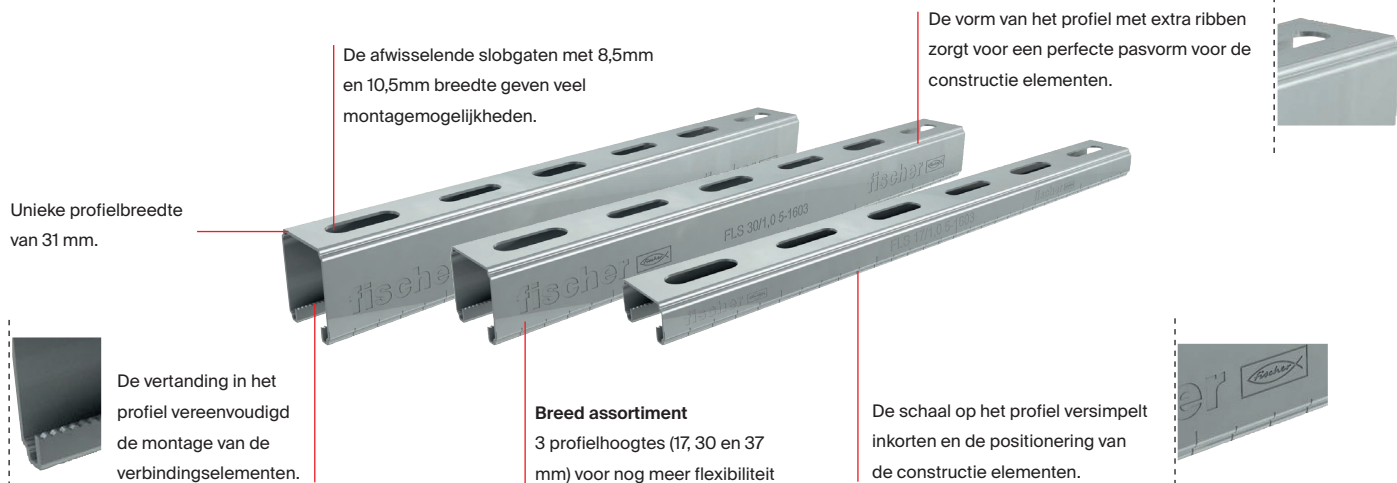

## Goedkeuringen



## Voorgemonteerde constructie elementen

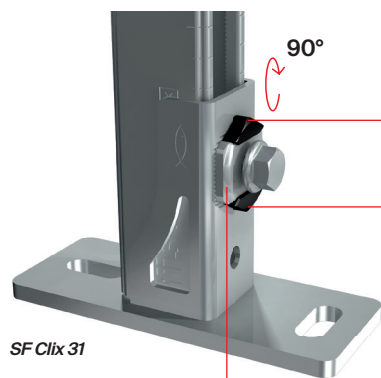

90°

Zeer snelle montage dankzij de Snelklikbout met 90°-rotatie.

Slechts één voorgemonteerd component staat tijdsbesparende en gemakkelijke montage toe.

Het unieke schuifstelsel garandeert een veilige positionering.

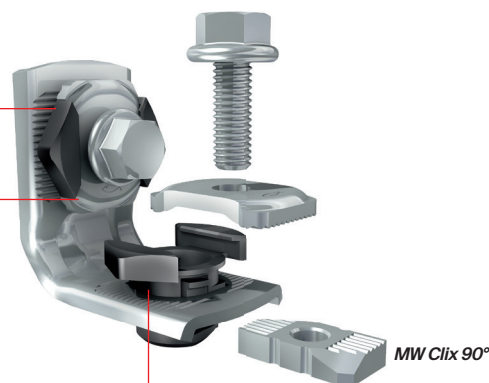

Het unieke schuifstelsel garandeert veilige positionering.

## FLS – Snel, stil en schoon

- Sneller werken met voorgemonteerde componenten
- Precies en foutloos positioneren van de componenten in de montagerail
- De unieke vertanding in de montagerail voorkomt ongewenst glijden van de hamerkopbout of schuifmoer
- De montagerail is makkelijk en geruisloos op maat te knippen
- Slijpen behoort tot de verleden tijd
- Stillere en nettere werken

## Constructie elementen met unieke eigenschappen

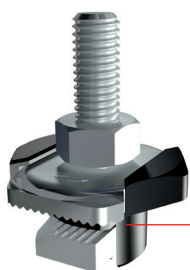

*FHS Clix*

Het verende element staat toe dat deze gemakkelijk gepositioneerd en gesteld kan worden.



### FLS – Sterk, stabiel en licht van gewicht

- Snel en gemakkelijk stevige installatie constructies
- Zeer breed toepasbaar
- Minder onderdelen en eenvoudige handelingen
- Meer componenten verwerken met minder gewicht
- Transport en logistiek worden efficiënter en goedkoper
- Geen besparing op draagkracht en kwaliteit

Het unieke en vlakliggende stop-element van de Snelklikmoer Clix P maakt veilige staal-op-staal verbinding mogelijk.

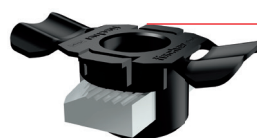

*FSM Clix P*

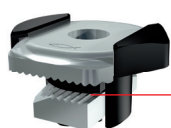

*FSM Clix M*

Het unieke stopelement garandeert precieze en foutloze 90°-montage in het profiel.



### FLS – Minder mankracht, makkelijk en flexibel

- De verwerking van het FLS montagesysteem is eenvoudig en minder belastend
- Er wordt niet ingeleverd op stabiliteit of kwaliteit
- Meer werk verzetten met minder mensen
- Minder onderdelen betekent minder kans op fouten
- Optimaal op elkaar afgestemde verbinding- en constructie elementen
- Ongekende inzetbaarheid

De karakteristieke borgklemmen garanderen een stabiele pasvorm in het profiel. Geschikt als profielverbinder evenals voor haakse montage van profielen.

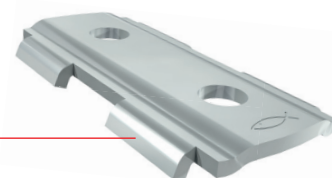



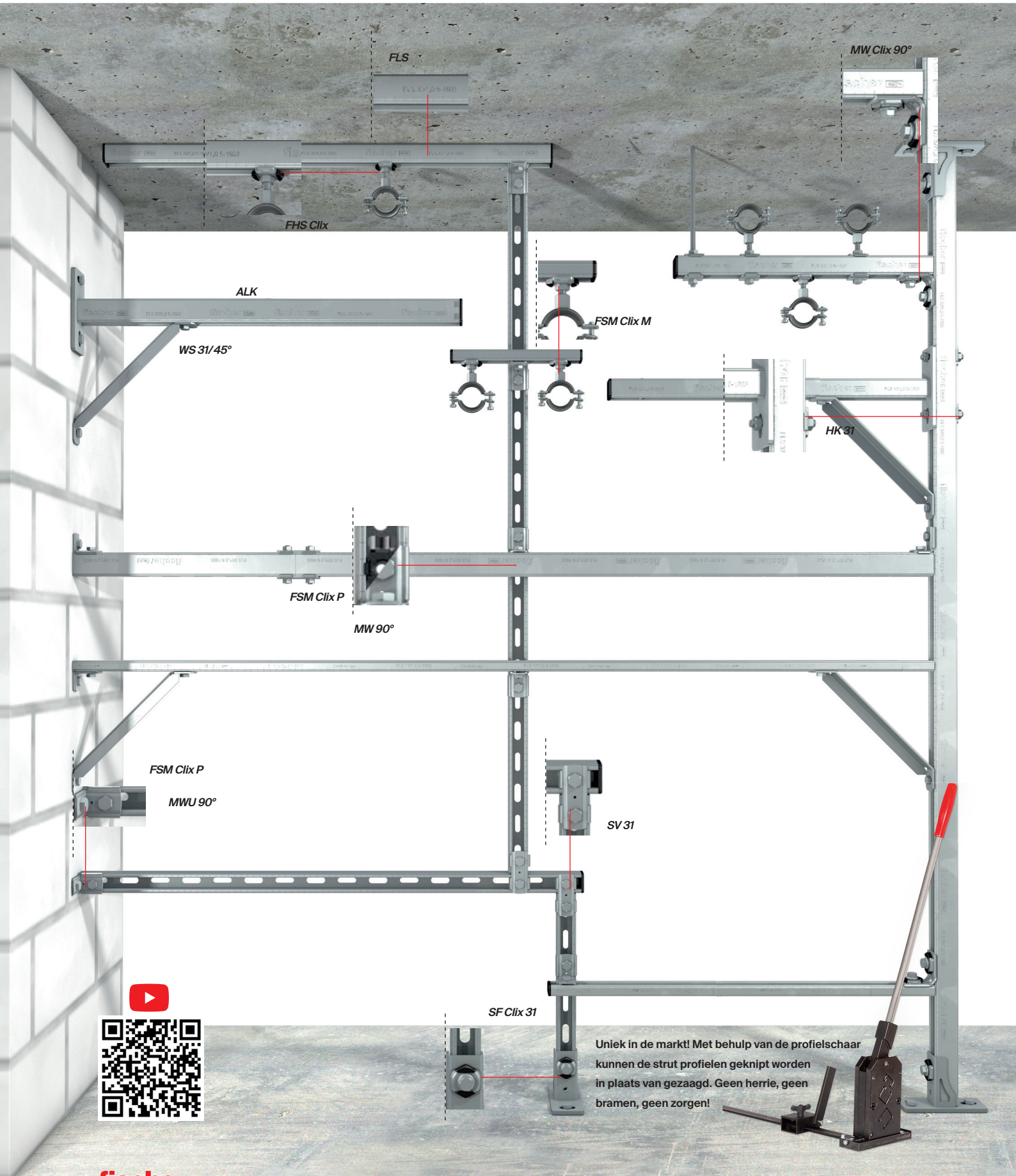

*SV 31*



# Overtuigend in applicatie.







# Assortiment

	Omschrijving	Art. nr.	VE [stuks]		Omschrijving	Art. nr.	VE [stuks]											
	Licht strut profiel FLS 17/1.0 - 2 m	538753	10		Montagehoek MW Clix 90°	538666	10											
	Licht strut profiel FLS 17/1.0 - 3 m	538754	8															
	Licht strut profiel FLS 30/1.0 - 2 m	538755	10															
	Licht strut profiel FLS 30/1.0 - 3 m	538756	8															
	Licht strut profiel FLS 37/1.2 - 2 m	538757	10															
	Licht strut profiel FLS 37/1.2 - 3 m	538758	8															
	Licht strut profiel FLS 37/1.2 - 6 m	538759	1															
	Console ALK 17-200	538738	10		Balkklem TKR 31	538751	25											
	Console ALK 17-300	538739	10															
	Console ALK 30-200	538740	10															
	Console ALK 30-300	538741	10															
	Console ALK 30-450	538742	10															
	Console ALK 37-300	538743	10															
	Console ALK 37-450	538744	10															
	Console ALK 37-600	538745	5															
	FLS Manuele profielschaar t.b.v. het knippen van strut profielen FLS 17, FLS 30 en FLS 37	543965	1		Hoekbeugel WS 31/45°	538749	10											
	Afdekkap AK 17	538746	100															
	Afdekkap AK 30	538747	100															
	Afdekkap AK 37	538748	100															
	Profielverbinder SV 31	538641	25						Klemplaat HK 31 8,5	538663	50							
												Klemplaat HK 31 10,5	538664	50				
	Snelklikmoer FSM Clix P 6	538643	50									Hamerkopbout FHS Clix 8 x 30	538653	100				
	Snelklikmoer FSM Clix P 8	538647	50												Hamerkopbout FHS Clix 8 x 40	538654	100	
	Snelklikmoer FSM Clix P 10	538649	50												Hamerkopbout FHS Clix 8 x 60	538655	100	
		Snelklikmoer FSM Clix M 6	538650												50	Hamerkopbout FHS Clix 8 x 80	538656	50
		Snelklikmoer FSM Clix M 8	538651												50	Hamerkopbout FHS Clix 8 x 100	538657	50
		Snelklikmoer FSM Clix M 10	538652												50	Hamerkopbout FHS Clix 8 x 140	545834	50
		Zadelflens SF Clix 31	538665												10	Hamerkopbout FHS Clix 8 x 190	545835	50
																Hamerkopbout FHS Clix 10 x 30	538658	100
				Hamerkopbout FHS Clix 10 x 40	538659	100												
		Montagehoek MWU 90° (8,5) t.b.v. montage aan ondergrond	538667	25	Hamerkopbout FHS Clix 10 x 60	538660	50											
Hamerkopbout FHS Clix 10 x 80					545836	50												
	Montagehoek MW 90° t.b.v. onderlinge montage profielen	538668	50	Hamerkopbout FHS Clix 10 x 100	538661	50												
					Rubber inlage EMS 31	538752	1											

	Omschrijving	Art. nr.	VE [stuks]
	FAZ II 8/10 <sup>1)</sup>	94871	50
	FAZ II 10/10 <sup>1)</sup>	94981	50
	FBS II 8x55 5/- US TX <sup>1)</sup>	536851	50
	FBS II 8x70 20/5 US TX <sup>1)</sup>	536852	50
	FBS II 6x40/5 LP <sup>1)</sup>	546379	100
	FBS II 6x80/25 P <sup>1)</sup>	546381	100

	Omschrijving	Art. nr.	VE [stuks]
	FBS II 6x35 M8/M10 I	546400	100
	FBS II 6x55 M8/M10 I	546401	100
	EA II M8x25 <sup>1)</sup>	532231	100
	EA II M10x25 <sup>1)</sup>	532232	50
	SXR L 10x60 FUS <sup>1)</sup>	546506	50

<sup>1)</sup> Meer afmetingen beschikbaar

Dealer:



---

fischer Benelux B.V.  
Postbus 5049  
1410 AA Naarden  
T 035 695 66 66  
[www.fischer.nl](http://www.fischer.nl) · [info@fischer.nl](mailto:info@fischer.nl)

---