

fischer 

DuoXpand.
Anchor with a
smart bite.



DuoXpand.

Clever combination of material and design.

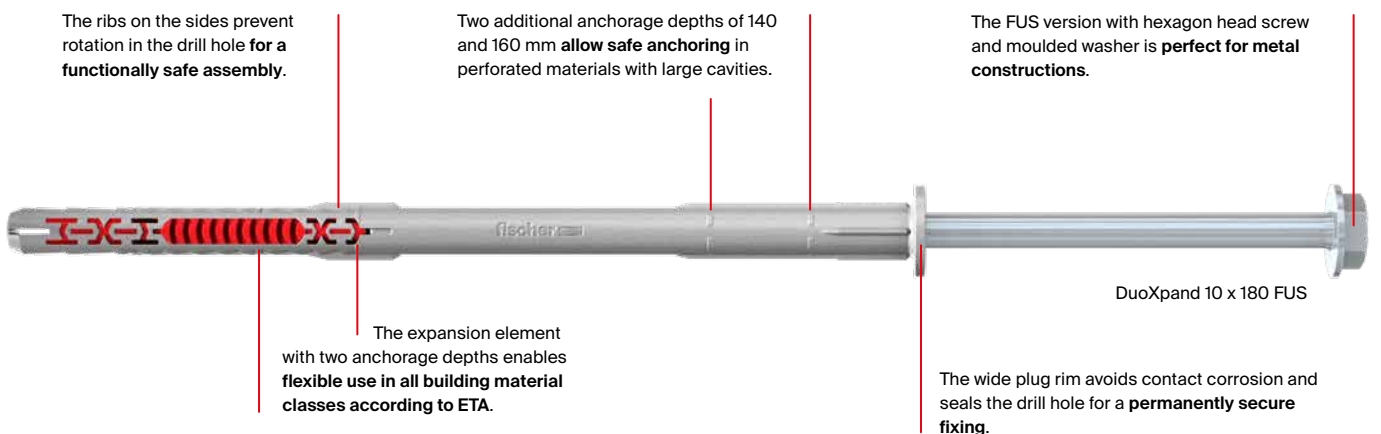
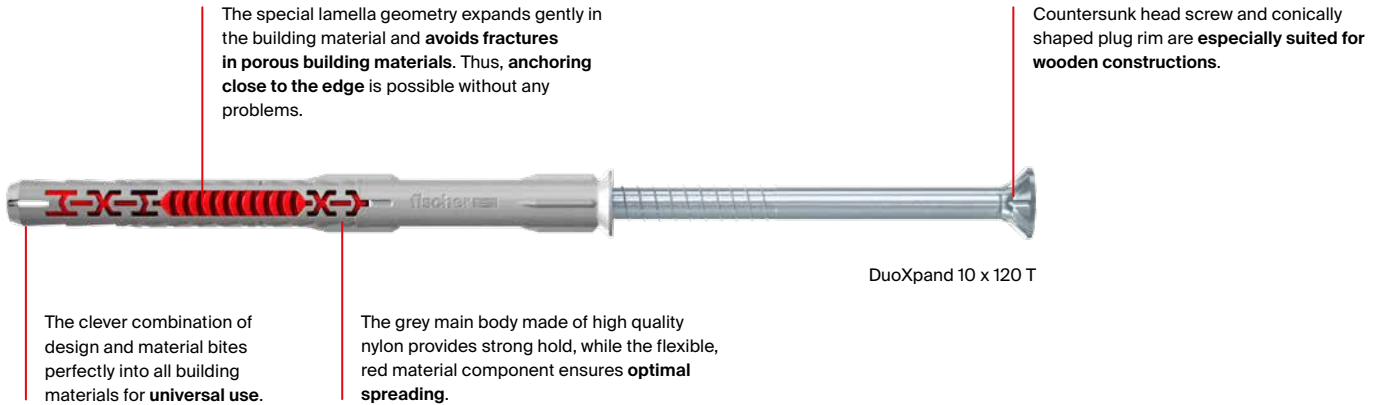

Advantages, functioning and certificates.

The advantages at a glance

- The combination of design and material adapts to all building materials and enables universal use.
- The special lamella geometry expands gently in the respective building material. This avoids fractures in porous building materials and enables anchoring close to the edge.
- The grey main body made of high-quality nylon provides the strength, while the red material component ensures flexibility and optimal spreading.
- The European Technical Assessment (ETA) for multiple use for non-structural applications ensures secure hold in all building material classes.
- The pre-mounted safety screw is perfectly matched to the plug and ensures time savings during installation.

Functioning

- The DuoXpand is suitable for push-through installation.
- In solid building materials, the product design guarantees equal load distribution into the substrate.
- In perforated bricks, the lamellas expand at the stone web and form an undercut in the cavity. The anchor geometry ensures that the force is transferred evenly to the material, so that porous stone webs are not destroyed.
- The version with countersunk screw is particularly suitable for fastening timber to concrete and masonry. For fixing metal, the version with a wide sleeve rim and a hexagon head screw with moulded washer is recommended.

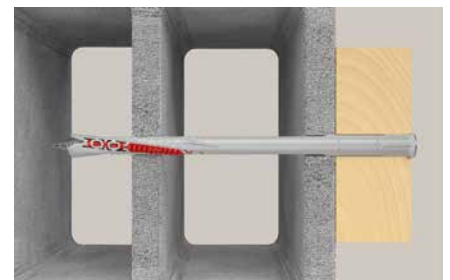
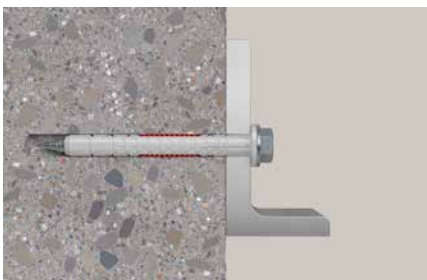

Certificates



ETA-21/0324,
Multiple use for
non-structural applications

Substrates and installation.

Substrates

Approved for:



Concrete



Solid sand-lime brick

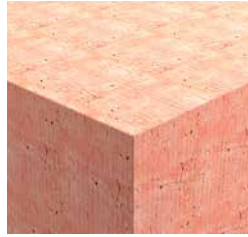

Solid brick

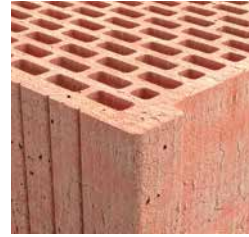

Vertically perforated brick



Perforated sand-lime brick



Hollow block made of light-weight concrete



Solid block made of light-weight concrete

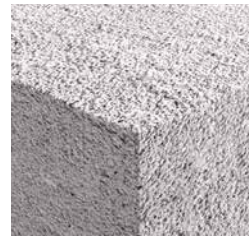

Aerated concrete

Installation of DuoXpand in solid brick

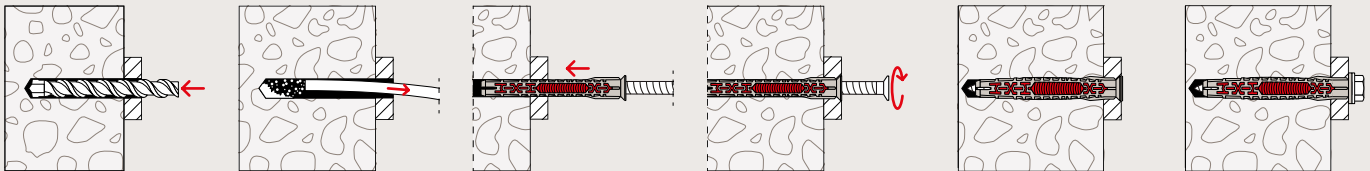

Installation of DuoXpand in perforated brick

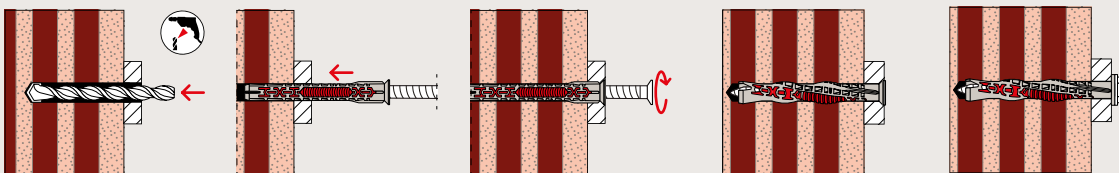

Applications

Wood applications



Timber substructures



Wood constructions



Carports

Metal applications



Facade substructures



Consoles



Canopies

Further applications



TV consoles



Kitchen cabinets



Window frames

Assortment

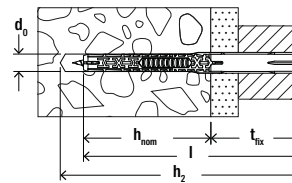

DuoXpand-T – with fischer countersunk head safety screw



Item	Item No.	Item No.	Approval	Drill hole diameter	Min. drill hole depth for through fixings	Usable length at anchorage depth				Anchor length	Drive	Sales unit
						t_{fix}	$h_{nom} = 50\text{ mm}$	$h_{nom} = 70\text{ mm}$	$h_{nom} = 140\text{ mm}$			
Description	Zinc-plated steel	Stain-less steel		d_0	h_2					l		
	gvz	R	ETA	[mm]	[mm]					[mm]		[pcs]
DuoXpand 8x80 T	562149	-	●	8	90	30	10	-	-	80	T30	50
DuoXpand 8x100 T	562150	-	●	8	110	50	30	-	-	100	T30	50
DuoXpand 8x120 T	562151	-	●	8	130	70	50	-	-	120	T30	50
DuoXpand 10x80 T	562155	562163	●	10	90	30	10	-	-	80	T40	50
DuoXpand 10x100 T	562156	562164	●	10	110	50	30	-	-	100	T40	50
DuoXpand 10x120 T	562157	562165	●	10	130	70	50	-	-	120	T40	50
DuoXpand 10x140 T	562158	562166	●	10	150	90	70	-	-	140	T40	50
DuoXpand 10x160 T	562159	-	●	10	170	110	90	20	-	160	T40	50
DuoXpand 10x180 T	562160	-	●	10	190	130	110	40	20	180	T40	50
DuoXpand 10x200 T	562161	-	●	10	210	150	130	60	40	200	T40	50
DuoXpand 10x230 T	562162	-	●	10	240	180	160	90	70	230	T40	50

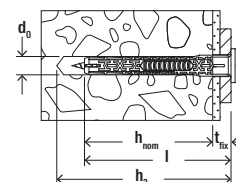

DuoXpand-FUS – with fischer hexagon head safety screw with moulded washer and integrated bit recess



Item	Item No.	Item No.	Approval	Drill hole diameter	Min. drill hole depth for through fixings	Usable length at anchorage depth				Anchor length	Drive	Sales unit
						t_{fix}	$h_{nom} = 50\text{ mm}$	$h_{nom} = 70\text{ mm}$	$h_{nom} = 140\text{ mm}$			
Description	Zinc-plated steel	Stain-less steel		d_0	h_2					l		
	gvz	R	ETA	[mm]	[mm]					[mm]		[pcs]
DuoXpand 8x80 FUS	562152	-	●	8	90	30	10	-	-	80	T30/SW10	50
DuoXpand 8x100 FUS	562153	-	●	8	110	50	30	-	-	100	T30/SW10	50
DuoXpand 8x120 FUS	562154	-	●	8	130	70	50	-	-	120	T30/SW10	50
DuoXpand 10x80 FUS	562167	562175	●	10	90	30	10	-	-	80	T40/SW13	50
DuoXpand 10x100 FUS	562168	562176	●	10	110	50	30	-	-	100	T40/SW13	50
DuoXpand 10x120 FUS	562169	562177	●	10	130	70	50	-	-	120	T40/SW13	50
DuoXpand 10x140 FUS	562170	562178	●	10	150	90	70	-	-	140	T40/SW13	50
DuoXpand 10x160 FUS	562171	-	●	10	170	110	90	20	-	160	T40/SW13	50
DuoXpand 10x180 FUS	562172	-	●	10	190	130	110	40	20	180	T40/SW13	50
DuoXpand 10x200 FUS	562173	-	●	10	210	150	130	60	40	200	T40/SW13	50
DuoXpand 10x230 FUS	562174	-	●	10	240	180	160	90	70	230	T40/SW13	50

Loads

Frame fixing DuoXpand

Permissible loads^{1/2/3)} of a single anchor as part of a multiple fixing of non-structural systems. For the design the complete current assessment ETA-21/0324 has to be considered.

Type			DuoXpand 8		DuoXpand 10		
Anchor diameter	d	[mm]					
Anchorage in concrete \geq C16/20⁴⁾							
Anchorage depth	$h_{nom} \geq$	[mm]	50	70	50	70	-
Permissible tensile load N_{perm}		[kN]	1.39	1.59	1.59	1.79	-
Permissible shear load V_{perm}	zinc coated screws (gvz)	[kN]	4.23	4.23	5.98	5.98	-
	stainless steel screw (R)	[kN]	3.93	3.93	5.98	5.98	-
Minimum member thickness	h_{min}	[mm]	80	100	80	100	-
Characteristic edge distance	$c_{ct,N}$	[mm]	50	50	50	50	-
Characteristic spacing	a resp. $s_{ct,N}$	[mm]	65	70	70	80	-
Minimum spacing with an edge distance	s_{min}	[mm]	50	50	50	50	-
	$c \geq$	[mm]	100	100	100	100	-
Minimum edge distance with a spacing	c_{min}	[mm]	50	50	50	50	-
	$s \geq$	[mm]	100	100	100	100	-
Anchorage in masonry^{5/6)}							
Anchorage depth	h_{nom}	[mm]	50	70	50	70	140
Permissible load F_{perm} in solid brick Mz, e.g. Ziegelwerk Nordhausen	$\geq NF; \geq 10 [N/mm^2] / \rho \geq 1.8 [kg/dm^3]$	[kN]	0.43	0.43	0.26	0.26	-
	$\geq NF; \geq 20 [N/mm^2] / \rho \geq 1.8 [kg/dm^3]$	[kN]	0.86	1.00	0.57	0.57	-
Permissible load F_{perm} in solid sand-lime brick KS, e.g. Wemding	$\geq NF; \geq 10 [N/mm^2] / \rho \geq 2.0 [kg/dm^3]$	[kN]	0.43	0.57	0.57	0.57	-
	$\geq NF; \geq 20 [N/mm^2] / \rho \geq 2.0 [kg/dm^3]$	[kN]	1.00	1.14	1.14	1.14	-
Permissible load ⁷⁾ F_{perm} in lightweight concrete block Vbl, e.g. KLB	$\geq 2 DF; \geq 2 [N/mm^2] / \rho \geq 1.4 [kg/dm^3]$	[kN]	0.11	0.17	0.09	0.17	-
	$\geq 2 DF; \geq 4 [N/mm^2] / \rho \geq 1.4 [kg/dm^3]$	[kN]	0.21	0.34	0.17	0.34	-
Permissible load ⁷⁾ F_{perm} in vertically perforated brick HLZ, e.g. Schlagmann	$3 DF; \geq 10 [N/mm^2] / \rho \geq 0.9 [kg/dm^3]$	[kN]	0.21	0.34	0.21	0.34	-
	$3 DF; \geq 12 [N/mm^2] / \rho \geq 0.9 [kg/dm^3]$	[kN]	0.26	0.43	0.26	0.43	-
Permissible load F_{perm} in perforated sand-lime brick KSL, e.g. Wemding	$3 DF; \geq 8 [N/mm^2] / \rho \geq 1.4 [kg/dm^3]$	[kN]	0.26	0.21	0.17	0.26	-
	$3 DF; \geq 16 [N/mm^2] / \rho \geq 1.4 [kg/dm^3]$	[kN]	0.43	0.43	0.34	0.57	-
Permissible load ⁷⁾ F_{perm} in hollow lightweight concrete blocks Hbl, e.g. Knobel, DE	$16 DF; \geq 2 [N/mm^2] / \rho \geq 0.7 [kg/dm^3]$	[kN]	0.14	0.14	0.21	0.21	-
	$16 DF; \geq 4 [N/mm^2] / \rho \geq 0.7 [kg/dm^3]$	[kN]	0.26	0.26	0.43	0.43	-
Permissible load ⁷⁾ F_{perm} in hollow lightweight concrete blocks Hbl, eg. Sepa Parpaing, FR	$\geq 2 [N/mm^2] / \rho \geq 1.0 [kg/dm^3]$	[kN]	0.09	-	0.14	0.14	-
	$\geq 4 [N/mm^2] / \rho \geq 1.0 [kg/dm^3]$	[kN]	0.21	0.14	0.26	0.26	0.14
Minimum member thickness	h_{min}	[mm]	115	115	115	115	200
Minimum spacing (single anchor)	a_{min}	[mm]	250	250	250	250	250
Minimum spacing (anchor group)	s_{min}	[mm]	100	100	100	100	100
Minimum edge distance (anchor group)	c_{min}	[mm]	100	100	100	100	100
Anchorage in aerated concrete⁸⁾							
Anchorage depth	$h_{nom} \geq$	[mm]	70	-	70	-	-
Permissible load F_{perm} in aerated concrete, acc.to EN 771-4:2011+A1:2015	AAC 2	[kN]	0.11	-	0.14	-	-
	AAC 4	[kN]	0.27	-	0.21	-	-
	AAC 6	[kN]	0.54	-	0.32	-	-
Permissible load F_{perm} in reinforced aerated concrete, acc. to EN 12602:2016	AAC 4; $f_{ck} \geq 4 N/mm^2$	[kN]	-	-	0.18	-	-
	AAC 6; $f_{ck} \geq 6 N/mm^2$	[kN]	-	-	0.32	-	-
Minimum member thickness	h_{min}	[mm]	100 / 175 ⁸⁾	-	100 / 175 ⁸⁾	-	-
Minimum spacing (single anchor)	a_{min}	[mm]	250	-	250	-	-
Minimum spacing (anchor group)	s_{min}	[mm]	100 / 80 ⁸⁾	-	100 / 80 ⁸⁾	-	-
Minimum edge distance (anchor group)	c_{min}	[mm]	100	-	100	-	-

¹⁾ Valid for zinc coated screws (gvz) and for screws made of stainless steel (R). For exterior use of the zinc coated screws measures against incoming humidity according to assessment have to be taken.

²⁾ The required partial safety factors for material resistance as well as a partial safety factor for load actions $\gamma_L = 1.4$ are considered.

As a single anchor counts e.g. an anchor with a minimum spacing a according to the ETA.

³⁾ Valid for temperatures in the substrate up to +50 °C (resp. short term up to +80 °C). For long term temperatures up to +30 °C higher permissible loads may be possible.

⁴⁾ For concrete specifications in C12/15, see ETA.

⁵⁾ Stone property data in min. compressive strength $[N/mm^2]$ and bulk density $[kg/dm^3]$. Corresponding mean compressive strengths according to EN 771 and other brick variants or brick geometries are listed in the ETA.

⁶⁾ Load data are valid for tensile load, shear load and oblique load under any angle. For bending moments and invisible or not mortar-filled joints the design specifications of the ETA must be observed.

⁷⁾ Rotary drilling method.

⁸⁾ Only valid for groups of anchors in AAC with compression strength $\geq 6 N/mm^2$.

Dealer:

www.fischer-international.com



fischer stands for

Fixing Systems
Automotive
fischertechnik
Consulting
Electronic Solutions

fischerwerke GmbH & Co. KG
Klaus-Fischer-Straße 1 · 72178 Waldachtal
Germany
T +49 7443 12 - 0
www.fischer-international.com · info@fischer.de
