



**Paslode®**

**FN1650.2**

**FN1850.2**



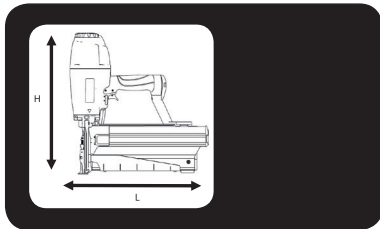

## FN1650.2



		<b>A = 270 mm</b> <b>B = 255 mm</b> <b>C = 65 mm</b>
		<b>kg = 1.34 kg</b>

<b>Min. 5,5 bar</b> <b>Max 8,0 bar</b>
<b>0,7 l (6 bar) /</b>
<b>Ps max. = 8,0 bar</b>

 <small>EN 12549+EN ISO 4871</small>	<b>L<sub>pA.1s1m</sub> = 80,7 dB(A)</b> <b>L<sub>pCpeak</sub> &lt; 130 dB(C)</b>
 <small>ISO 8662-11</small>	<b>Vibration = 1,6 m/s<sup>2</sup></b>







<b>85 x</b> =	
	<b>D = 2,80 x 1,63 mm</b> <b>d = 1,36 x 1,63 mm</b> <b>L = 15 - 50 mm</b>

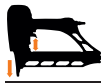

	<p>Sequential trigger actuation/ Einzelauslösung/ enkelschots/ Déclenchement du tir - mode séquentiel/ Funcionamiento secuencial "en continuo"/ Gatilho de actuação sequencial/ funzionamento sequenziale (colpo a colpo) Enkeltskuds aftrækker/ Enkelskott/ Enkeltskudds avtrekker/ Kertalaukaisu/ Úksiklasu meetodil töötamine/ Uruchomienie spustu sekwencyjne/ Sekvenčni spoušť/ Egyes lövés (szakaszosan működtetett elsütő billentyűvel)/ Posamezno proženje/ Kontaktirajte singl / Последовательная активация при нажатии на курок/ Sekvenčná aktivácia spúšte/ التشغيل بالزر التسلسلي المقيد / Nuoseklusis paleidimo mechanizmas/ Sekvencialās palaišanas iedarbināšana Raðkveikjuvirkjun</p>
	<p>Contact trigger actuation/ Kontaktauslösung/ repeterend schieten/ Déclenchement du tir - mode rafale/ Funcionamiento por contacto "clavo a clavo"/ Gatilho de actuação por contacto/ funzionamento a contatto/ Stødskydnings aftrækker/ Støtskjutning/ Støtspirkings avtrekker/ Kosketuslaukaisu/ Automaatmeetodil töötamine/ Uruchomienie spustu przez kontakt/ Kontaktní spoušť/ Sorozatlövés (folyamatosan behűzött elsütő billentyűvel)/ Kontaktno proženje/ Kontaktirajte pokretanje/ Контактная активация при нажатии на курок/ Kontaktná aktivácia spúšte/ التشغيل بتلامس الزر / Kontaktinis paleidimo mechanizmas/ Kontakta palaišanas iedarbināšana/ Snertikveikjuvirkjun</p>

**Model: FN1650.2 Sequential**  
**No. 576910**



					 2x
No. 576941	No.576928	No.576935	No. 014121		

**Accessories**

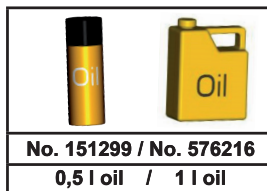

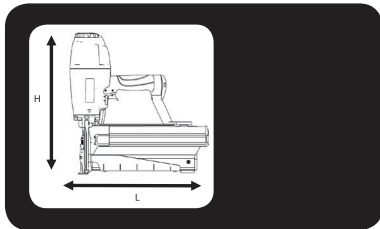

## FN1850.2



		<b>A = 270 mm</b> <b>B = 255 mm</b> <b>C = 65 mm</b>
		<b>= 1.34 kg</b>

<b>Min. 5,5 bar</b> <b>Max 8,0 bar</b>
<b>0,7 l (6 bar) /</b>
<b>Ps max. = 8,0 bar</b>

 <small>EN 12549+EN ISO 4871</small>	<b>L<sub>pA.1s1m</sub> = 85,3 dB(A)</b> <b>L<sub>pCpeak</sub> &lt; 130 dB(C)</b>
 <small>ISO 8662-11</small>	<b>Vibration = 1,7 m/s<sup>2</sup></b>







<b>115 x</b> =	
	<b>D = 1,90 x 1,25 mm</b> <b>d = 1,00 x 1,25 mm</b> <b>L = 16 - 50 mm</b>



	<p>Sequential trigger actuation/ Einzelauslösung/ enkelschots/ Déclenchement du tir - mode séquentiel/ Funcionamiento secuencial "en continuo"/ Gatilho de actuação sequencial/ funzionamento sequenziale (colpo a colpo) Enkeltskuds aftrækker/ Enkeltskott/ Enkeltskudds avtrekker/ Kertalaukaisu/ Üksiklasu meetodil töötamine/ Uruchomienie spustu sekwencyjne/ Sekvenčni spoušť/ Egyes lövés (szakaszosan müködötett elsütő billentyűvel)/ Posamezno proženje/ Kontaktirajte singl / Последовательная активация при нажатии на курок/ Sekvenčná aktivácia spúšte/ التشغيل بالزر التسلسلي المقيد / Nuoseklusis paleidimo mechanizmas/ Sekvencialās palai des iedarbināšana Raðkveikjувirkjun</p>
	<p>Contact trigger actuation/ Kontaktauslösung/ repeterend schieten/ Déclenchement du tir - mode rafale/ Funcionamiento por contacto "clavo a clavo"/ Gatilho de actuação por contacto/ funcionamento a contacto/ Stødskydnings aftrækker/ Støtskjutning/ Støtspikrings avtrekker/ Kosketuslaukaisu/ Automaatmeetodil töötamine/ Uruchomienie spustu przez kontakt/ Kontaktní spoušť/ Sorozatlövés (folyamatosan behúzott elsütő billentyűvel)/ Kontaktno proženje/ Kontaktirajte pokretanje/ Контактная активация при нажатии на курок/ Kontaktná aktivácia spúšte/ التشغيل بتلامس الزر / Kontaktnis paleidimo mechanizmas/ Kontakta palai des iedarbināšana/ Snertikveikjувirkjun</p>

**Model: FN1850.2 Sequential**  
**No. 576909**



					 2x
No. 576941	No.576928	No.576935	No. 014121		

**Accessories**

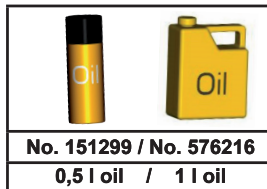

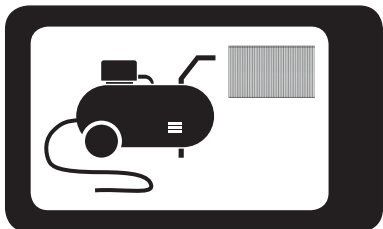

014 748

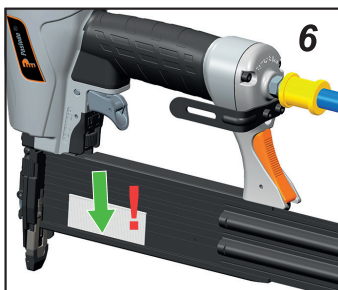
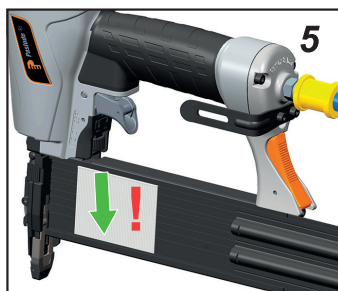
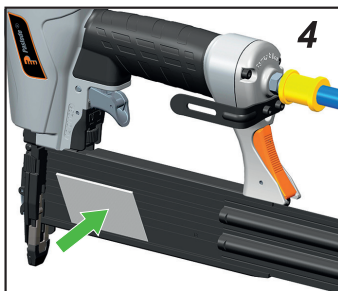
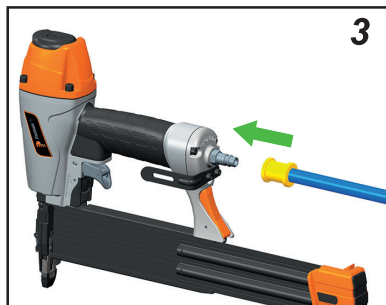
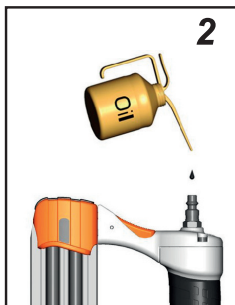
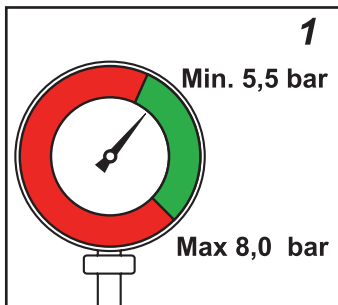

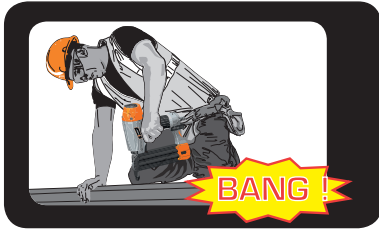

014 748

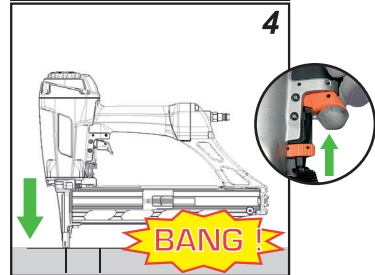
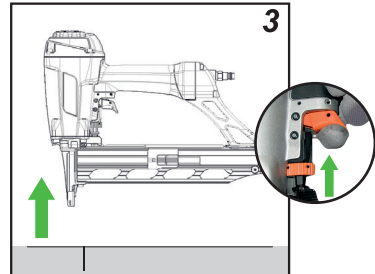
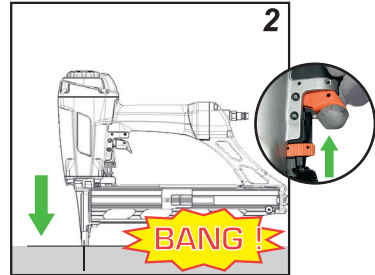
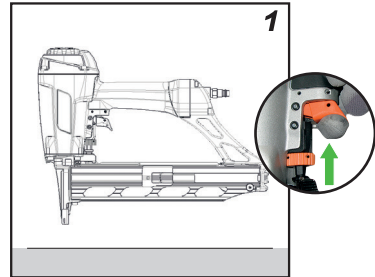
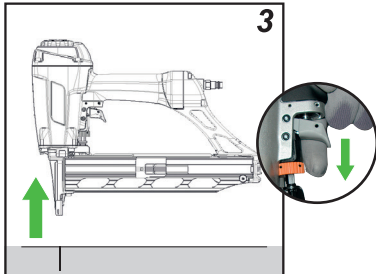
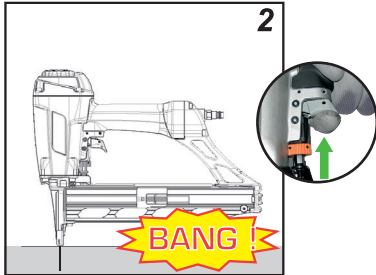
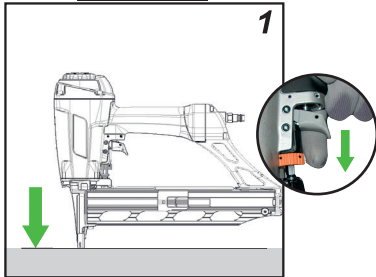

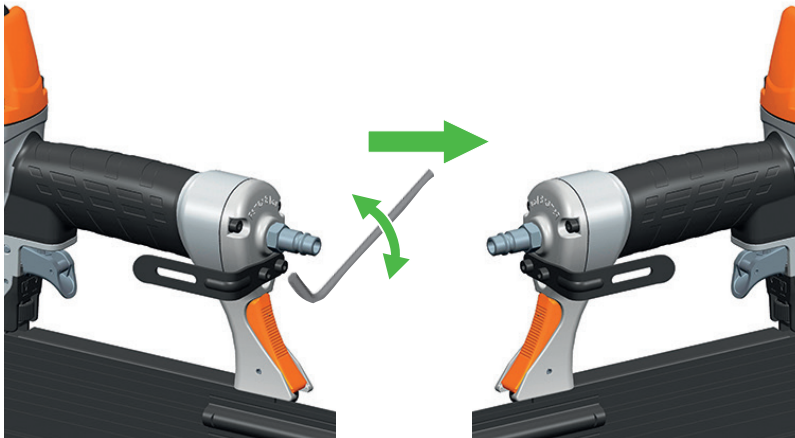
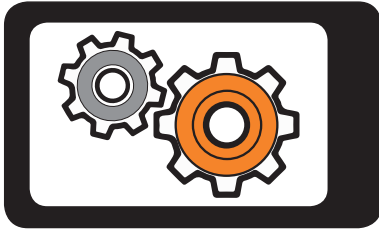



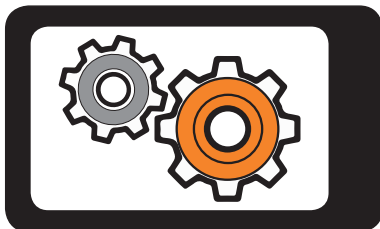

No.576928



No.576935

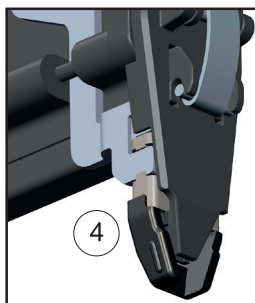
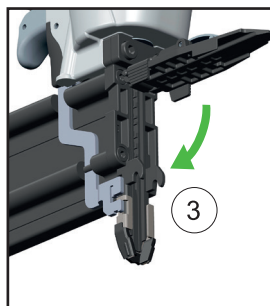
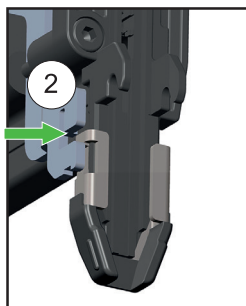
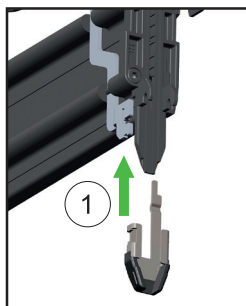
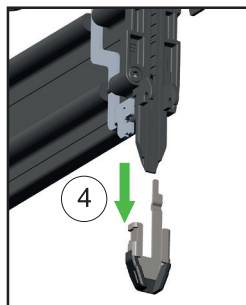
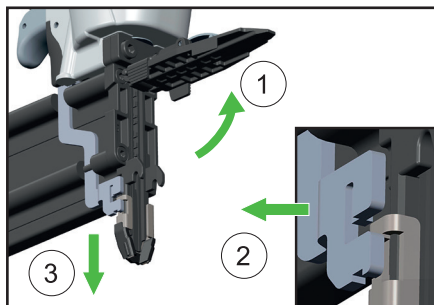

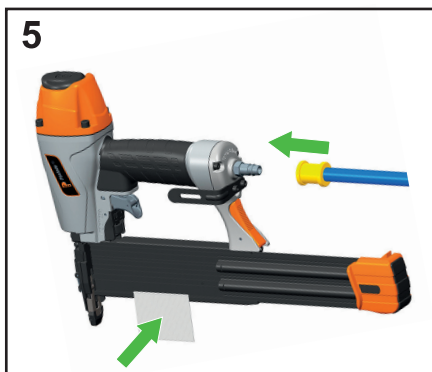
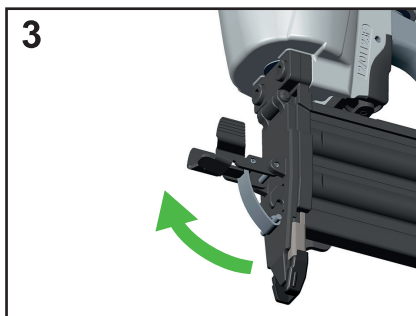
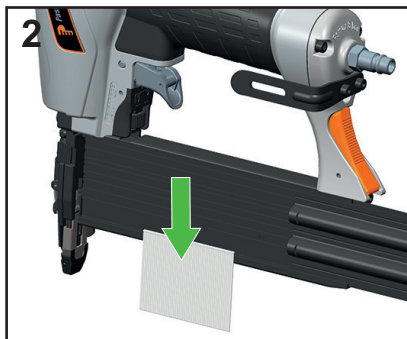
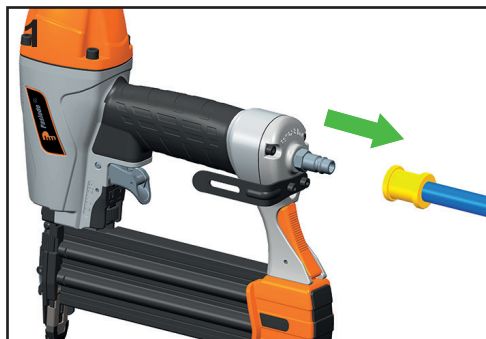
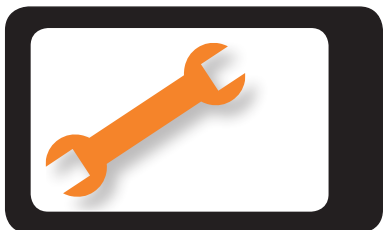

YY/WW....



YY= Year of manufacture  
WW = Week of manufacture



**Resting position/ Ruheposition/ Position de repos/ Ruststand/  
Posición de descanso/ Posizione di riposo/ Posição de des-  
canso/ Pozycja spoczynku/ Klidová poloha/ Nyugalmi állapot/  
Положение в нерабочем состоянии/ Θέση αδράνειας/ Hviles-  
tilling/ Viloläge/ Hvileposisjon/ Lepoasento/ Položaj mirovanja/  
Pokožová poloha/ Položaj mirovanja/ وضع السكون / Ramybės  
padėtis/ Ooteasend/ Miera stāvoklis/ Hvíldarstaða**



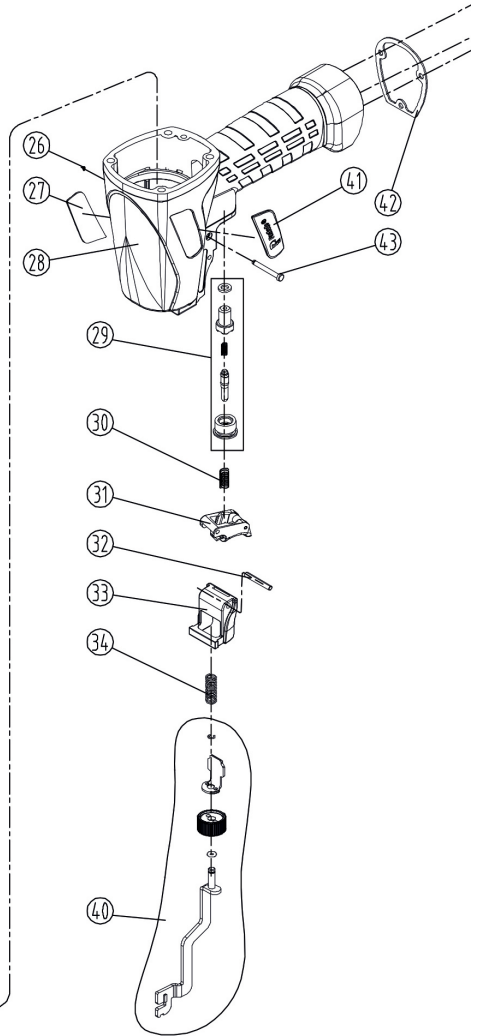
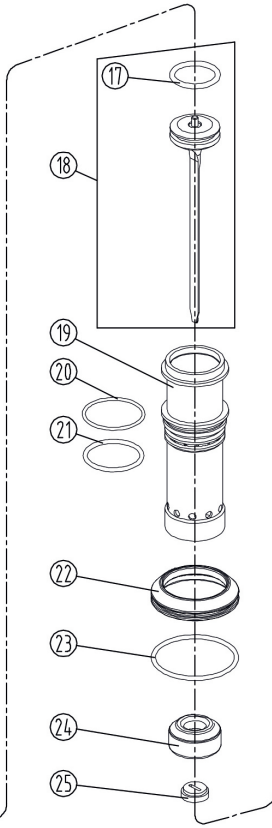
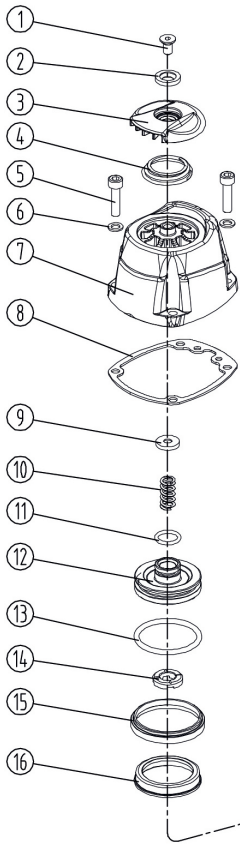

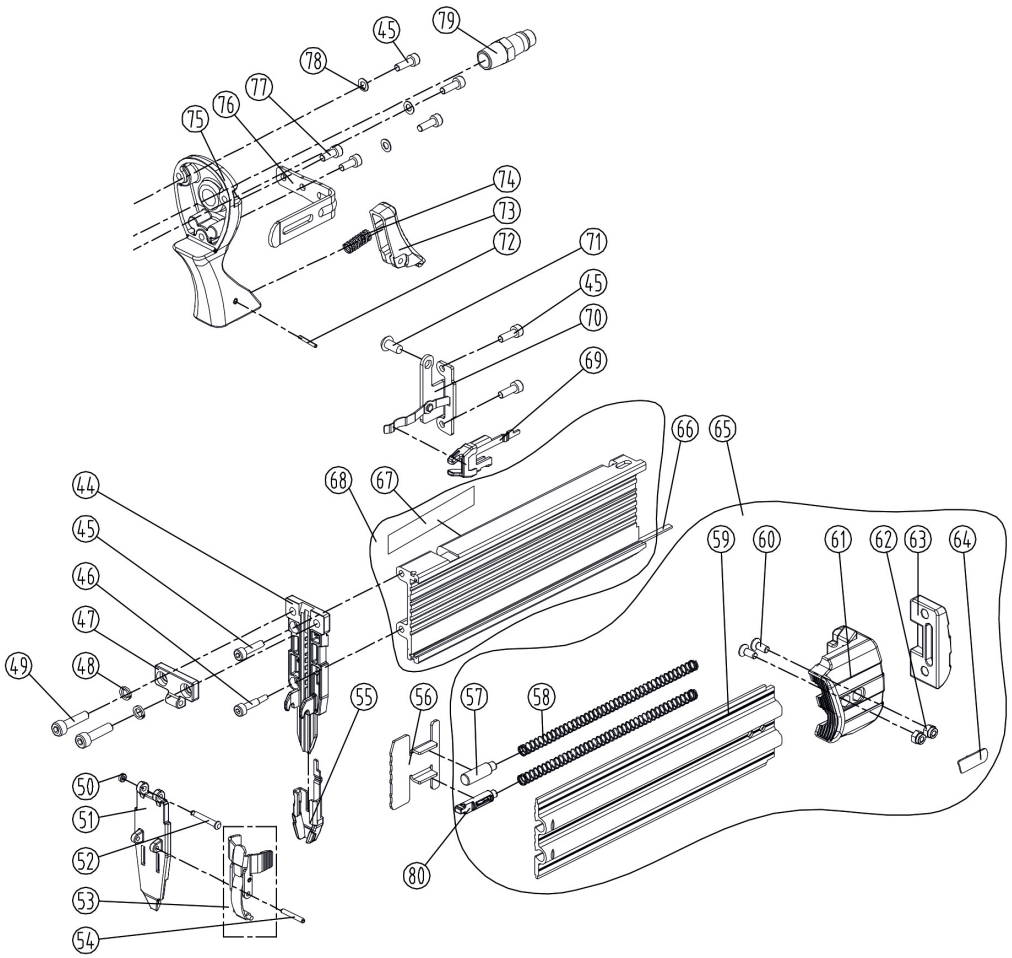

## FN1650.2

ITEM	ITW-Eurocode	DESCRIPTION
	<b>576910</b>	<b>FN1650.2 Sequential</b>
1	617539	Screw
2	617558	Bushing
3	617504	Exhaust Cover
4	576913	Spring
5	617533	Screw
6	617535	Washer
7	617489	Cylinder Cap
8	617550	Gasket
9	617548	Seal
10	617519	Spring
11	617521	O-Ring
12	617510	Valve
13	617527	O-Ring
14	617507	Piston Stop
15	617552	Restrict Washer
16	617551	Cylinder Seal
17	617523	O-Ring
18	576942	Piston Unit
19	617505	Cylinder
20	617524	O-Ring
21	617525	O-Ring
22	617503	Collar
23	617522	O-Ring
24	617506	Bumper
25	617508	Joint Guide
26	617526	O-Ring
27	617545	Logo-1
28	617488	Body
29	576915	Trigger Valve Unit
30	576916	Spring
31	576959	Trigger Contact Kit
31	576918	Trigger Sequential
32	617537	Spring Pin
33	617553	Safety Bracket
34	576919	Spring
40	576920	Safety Lever Unit
41	617544	Logo-2
42	617549	Gasket
43	617529	Pin
44	576943	Driver Guide
45	617531	Screw
46	576922	Screw
47	576923	Plate
48	576966	Spring Washer
49	576924	Screw
50	617547	Washer
51	576925	Front Plate
52	617530	Pin
53	576926	Lock Lever Unit
54	576927	Pin
55	576928	Work Piece Contact A
56	576944	Pusher
57	617520	Guide
58	576967	Spring
60	617538	Screw
61	617511	Rear Plate
62	617536	Nut
63	617556	Cover
64	617512	Cover
65	576945	Movable Magazine Unit
66	617496	Rail
67	576946	Type Label Sequential
67	576947	Type Label Contact
68	576948	Fixed Magazine Unit Contact
68	576949	Fixed Magazine Unit Sequential
69	576935	Work Piece Contact B
70	576936	Support
71	617540	Screw
72	617541	Pin
73	617555	Lock
74	576937	Spring
75	576938	End Cap
76	576939	Belt Hook
77	576940	Screw
78	617534	Washer
79	617509	Air Plug
80	576979	Guide
	576941	Manual

## FN1850.2

ITEM	ITW-Eurocode	DESCRIPTION
	<b>576909</b>	<b>FN1850.2 Sequential</b>
1	617539	Screw
2	617558	Bushing
3	617504	Exhaust Cover
4	576913	Spring
5	617533	Screw
6	617535	Washer
7	617489	Cylinder Cap
8	617550	Gasket
9	617548	Seal
10	617519	Spring
11	617521	O-Ring
12	617510	Valve
13	617527	O-Ring
14	617507	Piston Stop
15	617552	Restrict Washer
16	617551	Cylinder Seal
17	617523	O-Ring
18	576914	Piston Unit
19	617505	Cylinder
20	617524	O-Ring
21	617525	O-Ring
22	617503	Collar
23	617522	O-Ring
24	617506	Bumper
25	617508	Joint Guide
26	617526	O-Ring
27	617545	Logo-1
28	617488	Body
29	576915	Trigger Valve Unit
30	576916	Spring
31	576917	Trigger Contact Kit
31	576918	Trigger Sequential
32	617537	Spring Pin
33	617553	Safety Bracket
34	576919	Spring
40	576920	Safety Lever Unit
41	617544	Logo-2
42	617549	Gasket
43	617529	Pin
44	576921	Driver Guide
45	617531	Screw
46	576922	Screw
47	576923	Plate
48	576966	Spring Washer
49	576924	Screw
50	617547	Washer
51	576925	Front Plate
52	617530	Pin
53	576926	Lock Lever Unit
54	576927	Pin
55	576928	Work Piece Contact A
56	576929	Pusher
57	617520	Guide
58	576967	Spring
60	617538	Screw
61	617511	Rear Plate
62	617536	Nut
63	617556	Cover
64	617512	Cover
65	576930	Movable Magazine Unit
66	617496	Rail
67	576931	Type Label Sequential
67	576932	Type Label Contact
68	576933	Fixed Magazine Unit Contact
68	576934	Fixed Magazine Unit Sequential
69	576935	Work Piece Contact B
70	576936	Support
71	617540	Screw
72	617541	Pin
73	617555	Lock
74	576937	Spring
75	576938	End Cap
76	576939	Belt Hook
77	576940	Screw
78	617534	Washer
79	617509	Air Plug
80	576979	Guide
	576941	Manual

## GB DECLARATION OF CONFORMITY

FR DECLARATION DE CONFORMITE DE KONFORMITÄTSEKTLÄRUNG ES DECLARACIÓN DE CONFORMIDAD  
 PT DECLARAÇÃO DE CONFORMIDADE IT DICHIARAZIONE DI CONFORMITÀ NL CONFORIMITEISVERKLARING  
 DK OVERENSSTEMMELSESEKTLÆRING SE KONFORMITETSDEKLARATION NO SAMSVARSEKTLÆRING FI  
 YHDENMUKAISUUSILMOITUS PL DEKLARACJA ZGODNOŚCI CZ PROHLÁŠENÍ O SHODĚ HU PROHLÁŠENÍ O SHODĚ  
 GR ΔΗΛΩΣΗ ΣΥΜΜΟΡΦΩΣΗΣ RU ДЕКЛАРАЦИЯ СООТВЕТСТВИЯ ET VASTAVUSDEKLARATSIOON  
 LT ATITIKTIES DEKLARACIJA LV ATBILSTĪBAS DEKLARĀCIJA HR POLOŽAJ MIROVANJA SK VYHLÁŠENIE O ZHODE  
 VB IZJAVA O SKLADNOSTI AR وضع السكون ISL YFIRLÝSING UM SAMRÆMI

## PNEUMATIC TOOLS

ITW Befestigungssysteme GmbH  
 Carl - Zeiss - Straße 19  
 30966 HEMMINGEN - Germany

VALENCE, le 09/16



Gilles MARTINON  
 (R&D Manager)

GB	We declare that this product conforms with the standard or other standard documents. In accordance with the provisions of the EC Directives.
FR	Nous déclarons que ce produit est conforme aux normes ou autres documents normatifs. Conformément aux dispositions des Directives CE.
DE	Wir bestätigen, dass dieses Produkt den Normen bzw. sonstigen Regelwerken entspricht. Gemäß den Bestimmungen der EC-Richtlinien.
ES	Declaramos que este producto se conforma a las normas u otros documentos normativos. Conforme a lo establecido por las Directivas CE.
PT	Declaramos que este produto obedece às normas ou a outros documentos normativos. De acordo com as disposições das Directivas EC.
IT	Si dichiara che questo prodotto è conforme alle norme ovvero agli altri documenti normativi. In conformità alle disposizioni delle Direttive C.E.
NL	Wij verklaren dat dit product conform is met de normen en andere normatieve documenten. Conform met de bepalingen van de EEG-Richtlijnen.
DK	Erklærer vi, at dette produkt er i overensstemmelse med standarder og øvrige normative dokumenter. I henhold til bestemmelserne i EØF-direktiverne.
SE	Vi deklarerar att denna produkt är i överensstämmelse med standarderna och andra normativa dokument. Enligt bestämmelserna i EG-Direktiven.
NO	Vi erklærer at dette produktet er i overensstemmelse med alle standarder og normer. I overensstemmelse med EØF-direktivene.
FI	Ilmoitamme, että tämä tuote noudattaa normeja tai muita normatiivisia asiakirjoja. EC-direktiivien määräysten mukaisesti.
PL	Oświadczamy, że produkt jest zgodny z normami lub innymi dokumentami normatywnymi. Zgodnie z przepisami dyrektyw EC.
CS	Prohlašujeme, že tento výrobek je v souladu s normami či jinými normativními dokumenty. V souladu s ustanoveními směrníc EC.
HU	Kijelentjük, hogy ez a termék megfelel a szabványoknak és egyéb normatív dokumentumoknak. Az EGK irányelvekkel összhangban.
GR	Δηλώνουμε ότι το παρόν προϊόν συμφωνεί με τα πρότυπα και τα υπόλοιπα έγγραφα τυποποίησης. Σύμφωνα με τις διατάξεις των Οδηγιών ΕΟΚ.
RU	Мы заявляем, что это изделие соответствует нормам или другим нормативным документам. В соответствии с распоряжениями Директив ЕС.
ET	Käesolevaga kinnitame, et see toode vastab standardile või teistele standarddokumentidele EU direktiivi sätete kohaselt.
LT	Mes pareiškiame, jog šis produktas atitinka normas ir kitus normatyvinius dokumentus. Atitinka EB direktyvų nuostatas.
LV	Mēs paziņojam, ka šis izstrādājums atbilst standartam vai citiem standartu dokumentiem. Saskaņā ar EK direktīvas noteikumiem.
HR	Izjavljujemo da je ovaj proizvod u skladu sa standardom ili drugim standardnim dokumentima. U skladu s odredbama direktiva EU.
SK	Vyhlasujeme, že tento výrobok je v súlade s normou alebo inými štandardnými dokumentmi. V súlade s ustanoveniami smerníc EÚ.
VB	Izjavljamo, da je ta izdelek skladen s standardi ali drugimi standardnimi dokumenti. V skladu z določbami direktiv EU.
AR	نصرح ونعلن أن هذا المنتج مطابق لوثائق المعايير أو وثائق المعايير الأخرى طبقاً لنصوص توجيهات الاتحاد الأوروبي .
ISL	Við staðfestum að vara þessi uppfyllir staðlana eða önnur stöðluð gögn í samræmi við ákvæði tilskipana ESB.
EN792-13 + prISO 11148-13 - 2006/42/EC	



ITW CONSTRUCTION PRODUCTS EUROPE  
Code 576941 (02/2017)  
[www.paslode.eu](http://www.paslode.eu)