









MODELLEN / MODELS / MODÈLES / MODELLE
T123, R123



SPECIFICATIES T123 / SPECIFICATIONS T123 / CARACTERISTIQUES T123 / TECHNISCHE DATEN T123

		
433,92MHz	<20dBm	MN21

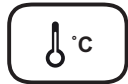
SPECIFICATIES R123 / SPECIFICATIONS R123 / CARACTERISTIQUES R123 / TECHNISCHE DATEN R123

						
12-24V AC/DC	max. 150mA @ 12V	10A, 30VDC	433,92MHz	-20°C ~ 60°C	0,5 ~ 60s	3 x 24

AFMETINGEN / DIMENSIONS / DIMENSIONS / ABMESSUNGEN

R123

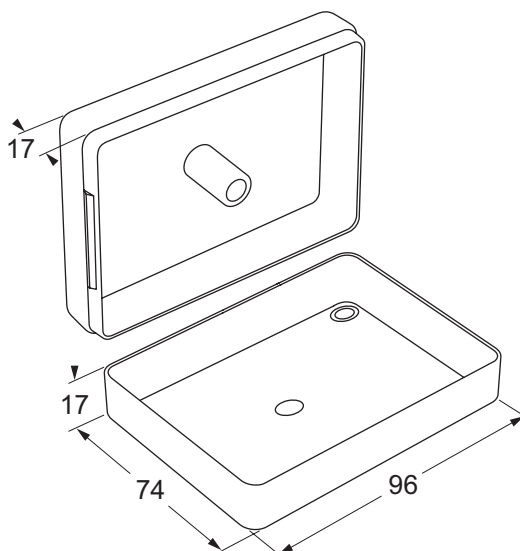

T123

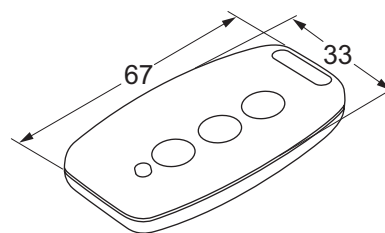

PROGRAMMERING

PROGRAMMERING:

- Druk op de "LEARN" knop van het te programmeren relais.
- De LED zal groen gaan branden.
- Druk op de gewenste knop van de handzender.
- De LED in de ontvanger zal 1 keer groen knipperen en uit gaan.



RESET:

Druk op de "LEARN" knop van het te wissen relais en houdt deze 4 seconden ingedrukt, daarna zal de LED 3 keer groen knipperen en uit gaan. Het relais geheugen is nu gewist.

TIMER:

Draai de potmeter naast de "LEARN" knop met de klok mee om de schakeltijd te verlengen (0,5 - 60 sec.). Maximaal met de klok mee gedraaid is de toggle functie ingeschakeld.

PROGRAMMING

PROGRAMMING:

- Press the "LEARN" button of the relay to be programmed.
- The LED will light green.
- Press the desired button of the remote.
- The LED in the receiver will flash green once and go out.



RESET:

Press the "LEARN" button of the relay to be deleted and hold it down for 4 seconds, then the LED will flash 3 times green and go out. The relay memory is now deleted.

TIMER:

Turn the potentiometer next to the "LEARN" knob clockwise to extend the switching time (0,5 - 60 sec.). The toggle function is on when potentiometer is turned maximum clockwise.

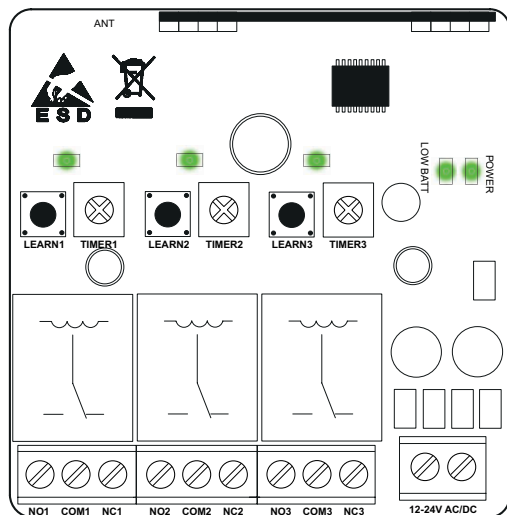

R123

PROGRAMMATION

PROGRAMMATION:

- Appuyez sur la touche "LEARN" du relais à programmer.
- La LED s'allume en vert.
- Appuyez sur le bouton souhaité de l'émetteur.
- La LED du récepteur clignotera une fois en vert et s'éteindra.



RÉINITIALISER:

Appuyez sur le bouton "LEARN" du relais à supprimer et maintenez-le enfoncé pendant 4 secondes. La LED clignotera 3 fois en vert et s'éteindra. La mémoire du relais est maintenant supprimée.

MINUTEUR (TIMER):

Tournez le potentiomètre situé à côté du bouton "LEARN" dans le sens des aiguilles d'une montre pour augmenter le minuteur (0,5 à 60 secondes). La fonction de basculement est activée lorsque le potentiomètre est tourné au maximum dans le sens des aiguilles d'une montre.

PROGRAMMIERUNG

PROGRAMMIERUNG:

- Drücken Sie die Taste „LEARN“ des zu programmierenden Relais.
- Die LED leuchtet grün.
- Drücken Sie die gewünschte Taste der Sender.
- Die LED im Empfänger blinkt einmal grün und erlischt.



RESET:

Drücken Sie die "LEARN" Taste des zu löschenden Relais und halten Sie die 4 Sekunden lang gedrückt. Dann blinkt die LED dreimal grün und erlischt. Der Relaispeicher ist nun gelöscht.

TIMER:

Drehen Sie das Potentiometer neben dem Knopf „LEARN“ im Uhrzeigersinn, um die Schaltzeit zu verlängern (0,5 - 60 Sek.). Die Umschaltfunktion ist eingeschaltet, wenn das Potentiometer maximal im Uhrzeigersinn gedreht wird.

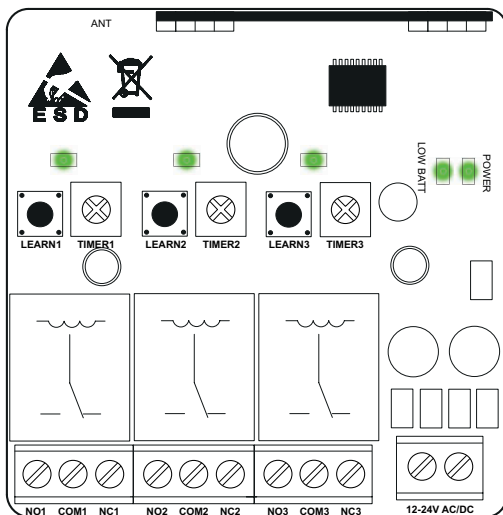

R123

POS:	ZENDER / TRANSMITTER / EMETTEUR / SENDER:	POS:	ZENDER / TRANSMITTER / EMETTEUR / SENDER:
01:		13:	
02:		14:	
03:		15:	
04:		16:	
05:		17:	
06:		18:	
07:		19:	
08:		20:	
09:		21:	
10:		22:	
11:		23:	
12:		24:	

POS:	ZENDER / TRANSMITTER / EMETTEUR / SENDER:	POS:	ZENDER / TRANSMITTER / EMETTEUR / SENDER:
01:		13:	
02:		14:	
03:		15:	
04:		16:	
05:		17:	
06:		18:	
07:		19:	
08:		20:	
09:		21:	
10:		22:	
11:		23:	
12:		24:	

POS:	ZENDER / TRANSMITTER / EMETTEUR / SENDER:	POS:	ZENDER / TRANSMITTER / EMETTEUR / SENDER:
01:		13:	
02:		14:	
03:		15:	
04:		16:	
05:		17:	
06:		18:	
07:		19:	
08:		20:	
09:		21:	
10:		22:	
11:		23:	
12:		24:	